

ONKYO®

MiniDisc Recorder

MD-2321

Instruction Manual

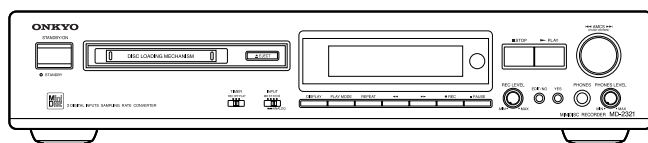

Thank you for purchasing the Onkyo MD-2321 Mini-Disc Recorder.

Please read this manual thoroughly before making connections and plugging in the unit.

Following the instructions in this manual will enable you to obtain optimum performance and listening enjoyment from your new MD-2321.

Please retain this manual for future reference.



Contents

Before using

Important Safeguards.....	2
Precautions	3
Features.....	4
Supplied accessories.....	4
Before operating this unit.....	5
System connections	6

Operation

Playing an MD.....	7
Recording to an MD	12
Using the program function (memory play)	19
Editing the contents of an MD.....	20
Naming a track or disc.....	24

A few important notes

Precautions for handling the MiniDisc (MD)	26
Message list	26
Troubleshooting guide.....	27
Rules for digital recording.....	28
System limitations	29

Other informations

Control positions and names	30
Specifications	31

WARNING:

TO REDUCE THE RISK OF FIRE OR ELECTRIC SHOCK, DO NOT EXPOSE THIS APPLIANCE TO RAIN OR MOISTURE.

CAUTION:

TO REDUCE THE RISK OF ELECTRIC SHOCK, DO NOT REMOVE COVER (OR BACK). NO USER-SERVICEABLE PARTS INSIDE. REFER SERVICING TO QUALIFIED SERVICE PERSONNEL.



WARNING
RISK OF ELECTRIC SHOCK
DO NOT OPEN

AVIS
RISQUE DE CHOC ELECTRIQUE
NE PAS OUVRIR



The lightning flash with arrowhead symbol, within an equilateral triangle, is intended to alert the user to the presence of uninsulated "dangerous voltage" within the product's enclosure that may be of sufficient magnitude to constitute a risk of electric shock to persons.



The exclamation point within an equilateral triangle is intended to alert the user to the presence of important operating and maintenance (servicing) instructions in the literature accompanying the appliance.

Important Safeguards

- Read Instructions** — All the safety and operating instructions should be read before the appliance is operated.
- Retain Instructions** — The safety and operating instructions should be retained for future reference.
- Heed Warnings** — All warnings on the appliance and in the operating instructions should be adhered to.
- Follow Instructions** — All operating and use instructions should be followed.
- Water and Moisture** — The appliance should not be used near water — for example, near a bathtub, washbowl, kitchen sink, laundry tub, in a wet basement, or near a swimming pool, and the like.
- Carts and Stands** — The appliance should be used only with a cart or stand that is recommended by the manufacturer.
- An appliance and cart combination should be moved with care. Quick stops, excessive force, and uneven surface may cause the appliance and cart combination to overturn.

PORTABLE CART WARNING



S3125A
- Wall or Ceiling Mounting** — The appliance should be mounted to a wall or ceiling only as recommended by the manufacturer.
- Ventilation** — The appliance should be situated so that its location or position does not interfere with its proper ventilation. For example, the appliance should not be situated on a bed, sofa, rug, or similar surface that may block the ventilation openings; or if placed in a built-in installation, such as a bookcase or cabinet that may impede the flow of air through the ventilation openings, there should be free space of at least 5 cm (2 in.) and open up behind the appliance.
- Heat** — The appliance should be situated away from heat sources such as radiators, heat registers, stoves, or other appliances (including amplifiers) that produce heat.
- Power Sources** — The appliance should be connected to a power supply only of the type described in the operating instructions or as marked on the appliance.
- Polarization** — If the appliance is provided with a polarized plug having one blade wider than the other, please read the following information: The polarization of the plug is a safety feature. The polarized plug will only fit the outlet one way. If the plug does not fit fully into the outlet, try reversing it. If there is still trouble, the user should seek the services of a qualified electrician. Under no circumstances should the user attempt to defeat the polarization of the plug.
- Power-Cord Protection** — Power-supply cords should be routed so that they are not likely to be walked on or pinched by items placed upon or against them, paying particular attention to the cords at plugs, convenience receptacles, and the point where they exit from the appliance.
- Cleaning** — The appliance should be cleaned only as recommended by the manufacturer.
- Nonuse Periods** — The power cord of the appliance should be unplugged from the outlet when left unused for a long period of time.
- Object and Liquid Entry** — Care should be taken so that objects do not fall and liquids are not spilled into the enclosure through openings.
- Damage Requiring Service** — The appliance should be serviced by qualified service personnel when:
 - The power-supply cord or the plug has been damaged; or
 - Objects have fallen, or liquid has been spilled into the appliance; or
 - The appliance has been exposed to rain; or
 - The appliance does not appear to operate normally or exhibits a marked change in performance; or
 - The appliance has been dropped, or the enclosure damaged.
- Servicing** — The user should not attempt to service the appliance beyond that described in the operating instructions. All other servicing should be referred to qualified service personnel.

**"CLASS 1 LASER
PRODUCT"**

This label on the rear panel states that:

- This unit is a CLASS 1 LASER PRODUCT and employs a laser inside the cabinet.
- To prevent the laser from being exposed, do not remove the cover. Refer servicing to qualified personnel.

Declaration of Conformity

We, ONKYO EUROPE
ELECTRONICS GmbH
INDUSTRIESTRASSE 20
82110 GERMERING,
GERMANY



declare in own responsibility, that the ONKYO product described in this instruction manual is in compliance with the corresponding technical standards such as EN55013, EN55020, EN61000-3-2, -3-3 and EN60065

GERMERING, GERMANY

K. OTSU

ONKYO EUROPE ELECTRONICS GmbH

Precautions

1. Warranty Claim

You can find the serial number on the rear panel of this unit. In case of warranty claim, please report this number.

2. Recording Copyright

Recording of copyrighted material for other than personal use is illegal without permission of the copyright holder.

3. Power

WARNING

BEFORE PLUGGING IN THE UNIT FOR THE FIRST TIME, READ THE FOLLOWING SECTION CAREFULLY.

The voltage of the available power supply differs according to country or region. Be sure that the power supply voltage in the area where this unit will be used meets the required voltage (e.g., AC 230 V 50 Hz or AC 120 V 60 Hz) written on the rear panel.

4. Do not touch this unit with wet hands

Do not handle this unit or the power cord when your hands are wet or damp. If water or any other liquid enters the case, take this unit to an authorized service center for inspection.

5. Location of this unit

- Place this unit in a well-ventilated location.
Take special care to provide plenty of ventilation on all sides of the unit especially when it is placed in an audio rack. If ventilation is blocked, the unit may overheat and malfunction.
- Do not expose this unit to direct sunlight or heating units as the unit's internal temperature may rise and shorten the life of the pickup.
- Avoid damp or dusty places and places directly affected by vibrations from the speakers. In particular, avoid placing the unit on or above one of the speakers.
- Be sure this unit is placed in a horizontal position. Never place it on its side or on a slanted surface as it may malfunction.
- Do not place the unit near tuners or TV sets.
If placed next to a TV or tuner, this unit may cause reception interference resulting in noise in the TV or tuner output.

6. Care

From time to time you should wipe off the front and rear panels and the cabinet with a soft cloth. For heavier dirt, dampen a soft cloth in a weak solution of mild detergent and water, wring it out, and wipe away the dirt. Following this, dry the unit immediately with a clean cloth. Do not use rough material, thinners, alcohol or other chemical solvents or cloths since these may damage the finish or remove the panel lettering.

7. Points to remember

- If this unit is brought from a cold environment to a warm one or is in a cold room that is quickly heated, condensation may form on the pickup, preventing proper operation. In this case, remove the disc and leave the power ON for about one hour to remove the condensation.
- When transporting this unit, be careful not to bump it.

This unit contains a semiconductor laser system and is classified as a "CLASS 1 LASER PRODUCT". So, to use this model properly, read this Owner's Manual carefully. In case of any trouble, please contact the store where you purchased the unit. To prevent being exposed to the laser beam, do not try to open the enclosure.

DANGER:

INVISIBLE LASER RADIATION WHEN OPEN AND INTER-LOCK FAILED OR DEFEATED. AVOID DIRECT EXPOSURE TO BEAM.

CAUTION:

THIS PRODUCT UTILIZES A LASER. USE OF CONTROLS OR ADJUSTMENTS OR PERFORMANCE OF PROCEDURES OTHER THAN THOSE SPECIFIED HEREIN MAY RESULT IN HAZARDOUS RADIATION EXPOSURE.

For U.S.A. Model

The laser is covered by a housing which prevents exposure during operation or maintenance. However, this product is classified as a Laser Product by CDRH (Center for Devices and Radiological Health) which is a department of the Food and Drug Administration. According to their regulations 21 CFR section 1002.30, all manufacturers who sell Laser Products must maintain records of written communications between the manufacturer, dealers and customers concerning radiation safety. If you have any complaints about instructions or explanations affecting the use of this product, please feel free to write to the address on the back page of this manual. When you write us, please include the model number and serial number of your Mini Disc recorder.

In compliance with Federal Regulations, the certification, identification and the period of manufacture are indicated on the rear panel.

FCC INFORMATION FOR USER

CAUTION:

Changes or modifications not expressly approved by the manufacturer for compliance could void the user's authority to operate the equipment.

NOTE:

This equipment has been tested and found to comply with the limits for a Class B digital device, pursuant to Part 15 of the FCC Rules. These limits are designed to provide reasonable protection against harmful interference in a residential installation. This equipment generates, uses, and can radiate radio frequency energy and, if not installed and used in accordance with the instructions, may cause harmful interference to radio communications. However, there is no guarantee that interference will not occur in a particular installation. If this equipment does cause harmful interference to radio or television reception, which can be determined by turning the equipment off and on, the user is encouraged to try to correct the interference by one or more of the following measures:

- Reorient or relocate the receiving antenna.
- Increase the separation between other equipment and the receiver.
- Connect the equipment into an outlet on a circuit different from that to which the receiver is connected.
- Consult the dealer or an experienced radio/TV technician for help.

Precautions

For British model

Replacement and mounting of an AC plug on the power supply cord of this unit should be performed only by qualified service personnel.

- **IMPORTANT**

The wires in the mains lead are coloured in accordance with the following code:

Blue : Neutral

Brown : Live

As the colours of the wires in the mains lead of this apparatus may not correspond with the coloured markings identifying the terminals in your plug, proceed as follows:

The wire which is coloured blue must be connected to the terminal which is marked with the letter N or coloured black.

The wire which is coloured brown must be connected to the terminal which is marked with the letter L or coloured red.

- **IMPORTANT**

A 5 amp fuse is fitted in this plug. Should the fuse need to be replaced, please ensure that the replacement fuse has a rating of 5 amps and that it is approved by ASTA or BSI to BS1362. Check for the ASTA mark or the BSI mark on the body of the fuse.

IF THE FITTED MOULDED PLUG IS UNSUITABLE FOR THE SOCKET OUTLET IN YOUR HOME THEN THE FUSE SHOULD BE REMOVED AND THE PLUG CUT OFF AND DISPOSED OF SAFELY. THERE IS A DANGER OF SEVERE ELECTRICAL SHOCK IF THE CUT OFF PLUG IS INSERTED INTO ANY 13 AMP SOCKET.

If in any doubt, please consult a qualified electrician.

For Canadian model

Modele pour les Canadien

- For models having a power cord with a polarized plug:

CAUTION: TO PREVENT ELECTRIC SHOCK, MATCH WIDE BLADE OF PLUG TO WIDE SLOT, FULLY INSERT.

THIS DIGITAL APPARATUS DOES NOT EXCEED THE CLASS B LIMITS FOR RADIO NOISE EMISSION FROM DIGITAL APPARATUS SET OUT IN THE RADIO INTERFERENCE REGULATIONS OF THE CANADIAN DEPARTMENT OF COMMUNICATIONS.

- Sur les modèles dont la fiche est polarisée:

ATTENTION: POUR ÉVITER LES CHOCS ÉLECTRIQUES, INTRODUIRE LA LAME LA PLUS LARGE DE LA FICHE DANS LA BORNE CORRESPONDANTE DE LA PRISE ET POUSSER JUSQU'AU FOND.

L'INTERFÉRENCE RADIO ÉLECTRIQUE GÉNÉRÉE PAR CET APPAREIL NUMÉRIQUE DE TYPE B NE DÉPASSE PAS LES LIMITES ÉNONCÉES DANS LE RÈGLEMENT SUR LES PERTURBATIONS RADIO ÉLECTRIQUES, SECTION APPAREIL NUMÉRIQUE, DU MINISTÈRE DES COMMUNICATIONS.

Memory Preservation

This unit does not require memory preservation batteries. A built-in memory power back-up system preserves the contents of the memory during power failures and even when the unit is unplugged. The unit must be plugged-in to charge the back-up system.

The memory preservation period after the unit has been unplugged varies depending on climate and placement of the unit. On the average, memory contents are protected over a period of a few weeks after the last time the unit was unplugged. This period is shorter when the unit is exposed to a highly humid climate.

Features

- Onkyo Sonic Performance and Onkyo Quality at a Very Competitive Price
- Front-panel Analog Stereo/Mono Switch
- 2 Digital Inputs (1 Optical, 1 Coaxial)
- 1 Digital Optical Output
- Built-in Sampling Rate Converter
- Convenient Jog Dial for Track Selection & Character Input
- Brushed Aluminum Front Panel
- **RI** Compatible Full-Function Remote Controller

Supplied accessories

Check that the following accessories are supplied with this unit. The number of each supplied accessory is indicated in parentheses.

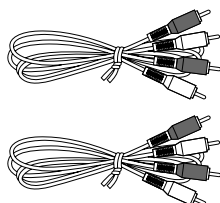

Audio connection cable (2)

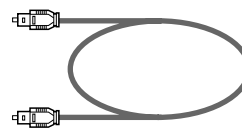

Optical cable (1)



RI cable (1)

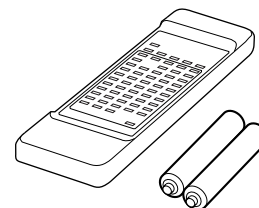

Remote controller (1)
Dry batteries UM-3 (2)

Before operating this unit

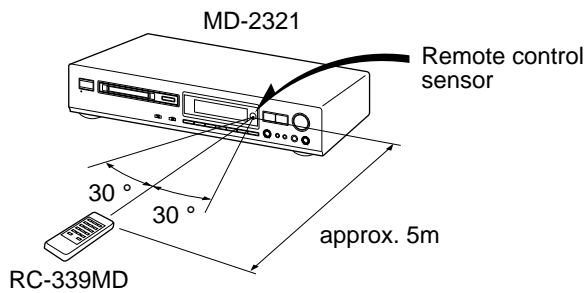
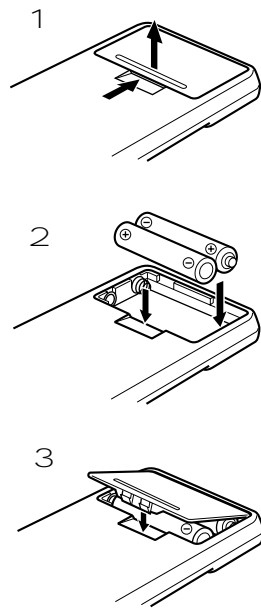

Inserting the remote controller batteries

Remove the battery compartment cover by opening it as shown in the illustration. Load two R6 (UM-3) AA size batteries into the remote controller with the plus (+) and minus (-) terminals positioned as indicated by the diagram inside the battery compartment. Close the battery compartment cover.

- Remove dead batteries immediately to avoid corrosion.
- To avoid potential corrosion, never mix old batteries with new ones.
- The manganese batteries supplied with this unit have a service life of approximately six months, depending on frequency of usage.
- This unit comes equipped with R6 (UM-3) AA manganese batteries, but we recommend that you use long-life alkaline batteries LR6 (AM-3) AA when replacing the batteries.

Using the remote controller

The following information will be helpful for the optimum operation of the RC-339MD.

- Place the MD-2321 away from direct bright light, which can prevent proper operation of the remote controller.
- Make sure audio rack doors do not have coloured glass. If the MD-2321 is placed behind such a door, the RC-339MD may not operate properly.
- Using other remote controllers in the same room as the MD-2321 may interfere with the operation of the RC-339MD.

System connections

Connecting other components

- Do not plug in the AC power cord until all other connections have been made.
- On each pair of input or output jacks, the jack marked R corresponds to the right channel, and the jack marked L to the left channel. Refer to the amplifier's instruction manual for further information on connections.
- Do not place the MD recorder on the amplifier or receiver.
- Do not fold optical cables into a short length or wind them up into a coil with a small radius.
- Avoid bundling the audio connection cables with the power cord or speaker cables. Doing so may degrade sound reproduction.
- Insert the plugs and connectors securely. Remember that improper connection can result in noise, poor performance, or damage to the equipment.

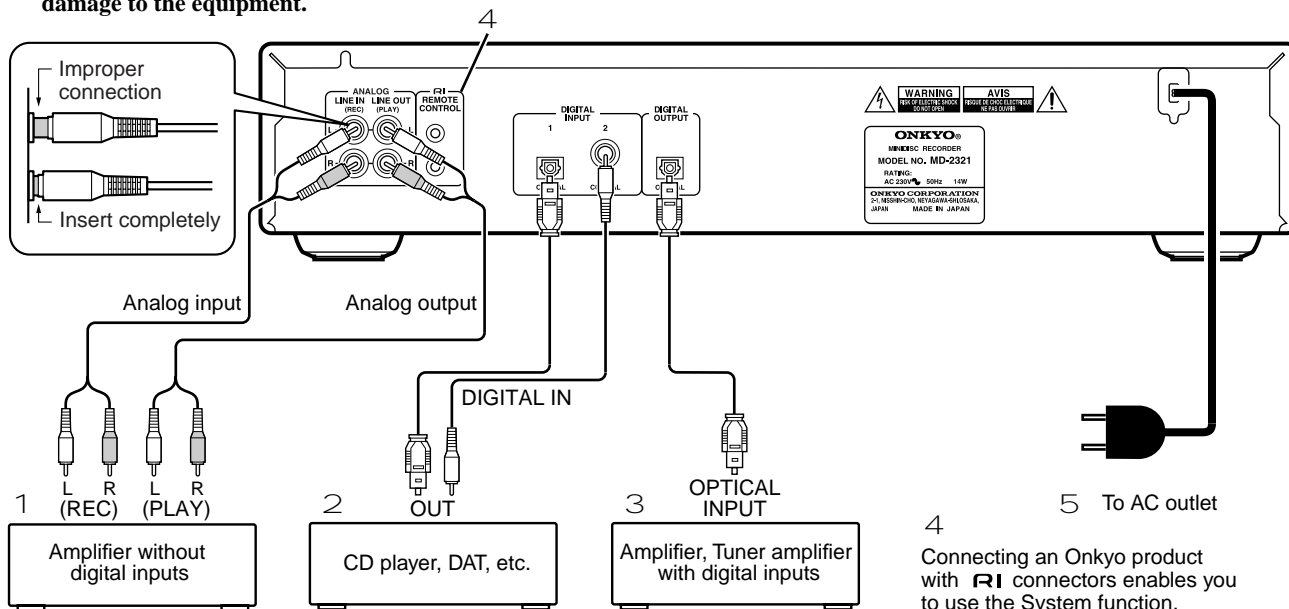

A Connection with the amplifier

Connect the MD-2321 to the MD (or TAPE) jacks of your amplifier.

B Connection via the digital input terminal (DIGITAL INPUT)

You can perform digital recording on the MD-2321 if a CD (Compact Disc) player or DAT (Digital Audio Tapedeck) equipped with a digital (OPTICAL) output terminal is available. For digital recording, you need to connect the equipment to either DIGITAL IN 1 or 2 terminal. Use an optical cable to connect DIGITAL INPUT 1, and use a coaxial cable to connect DIGITAL INPUT 2. These terminals can also be used for connecting an amplifier which is equipped with a digital output terminal.

Note:

- If you attempt to perform digital recording using a digital input terminal that is not connected properly, "D.In Unlock" will appear.
- Terminal protection caps are attached to the DIGITAL IN terminals. Remove the cap for the terminal you wish to use when connecting the MD-2321 to digital equipment. Replace the caps if you are not using the DIGITAL IN terminals.

C Connection via the digital output terminal (DIGITAL OUTPUT)

Connect this terminal to DIGITAL INPUT of an amplifier or tuner amplifier to enjoy clearer and dynamic sound.

D Connections for remote control

When the MD-2321 is connected to an amplifier with the Onkyo RI jack, pressing the MD button on the amplifier's remote controller enables you to operate the MD recorder.

Note:

- The upper and lower RI remote control jacks have the same function.
- Remote control operation is not possible when only the remote control cable is connected – the audio cables must also be connected.

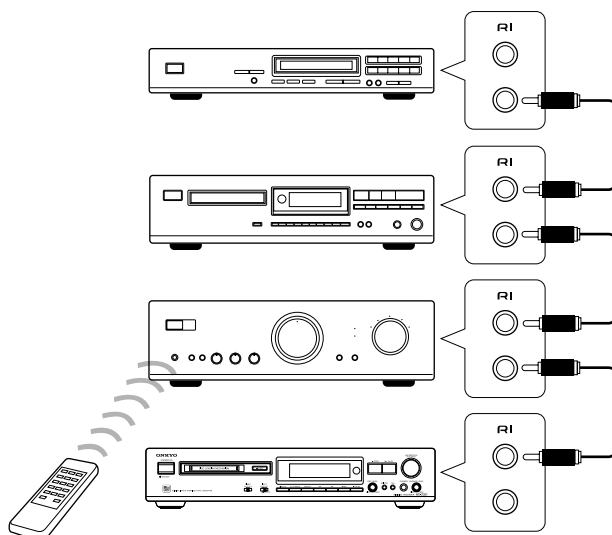

E Connecting the AC power cord and turning the power on

1. Insert the AC power cord into a wall outlet.
2. Press the STANDBY/ON button. The display will light.

Note:

To insert the AC power cord into an AC outlet on the rear panel of another component, use the UNSWITCHED outlet.

Playing an MD

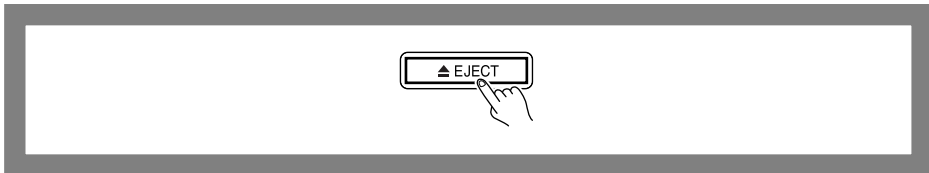
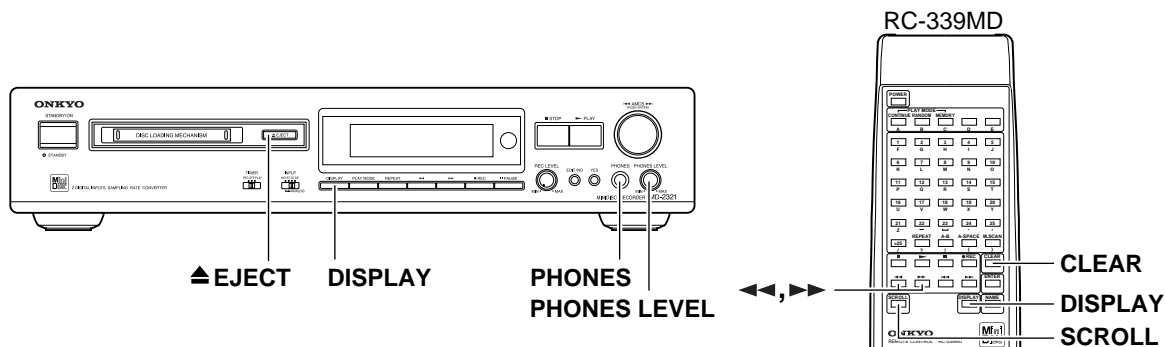

Ejecting a MiniDisc

Press the **▲ EJECT** button. The MiniDisc is ejected and “Eject” appears on the display.

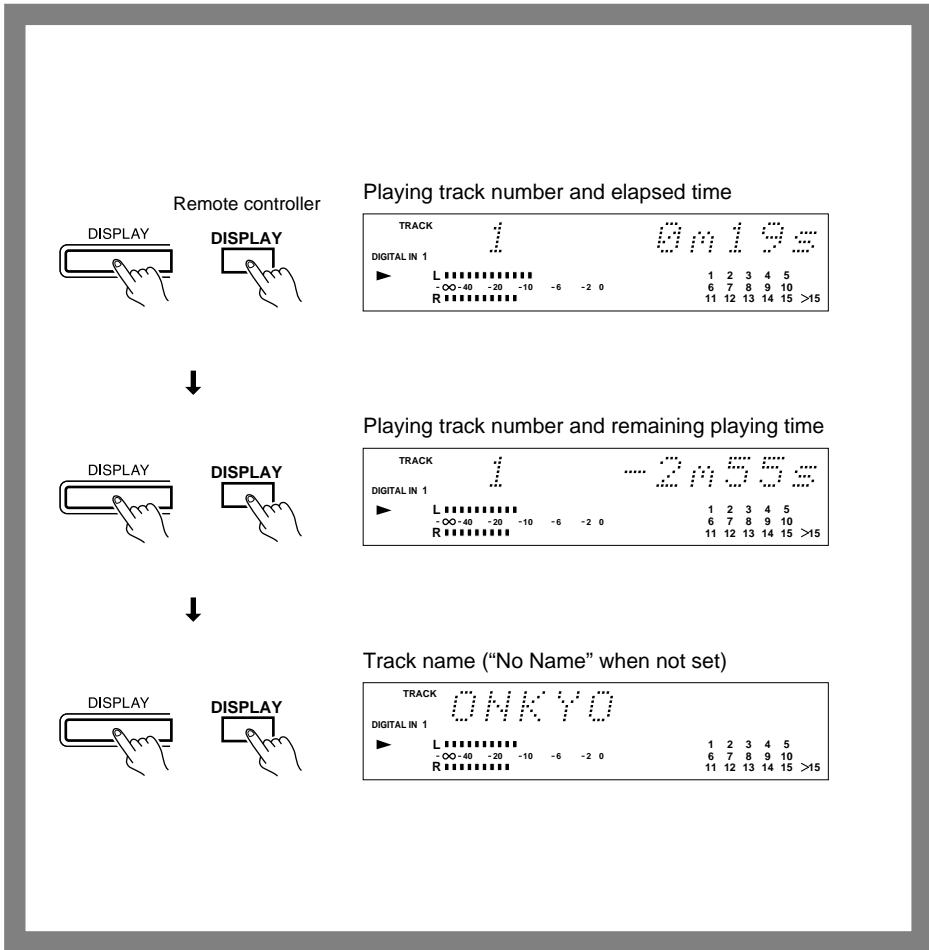

Changing the display mode

When the MD recorder is playing...
Each press of the DISPLAY button changes the display in the following sequence:
The number and elapsed time of the current track

↓
The number and remaining playback time of the current track

↓
Track name (“No Name” appears if the track is not named.)

When the MD recorder is stopped...
Each press of the DISPLAY button changes the display in the following sequence:
Total number of tracks on the MD and its total playing time

↓
Time remaining for recording on the MD (Not displayed if it is a premastered MD)

↓
Disc name (“No Name” appears if the disc is not named.)

If the track or disc name is too long to display...
You can scroll the name by pressing the SCROLL button on the remote controller. Press the SCROLL button again to stop scrolling the name.
To exit display scroll mode, press the CLEAR button on the remote controller.

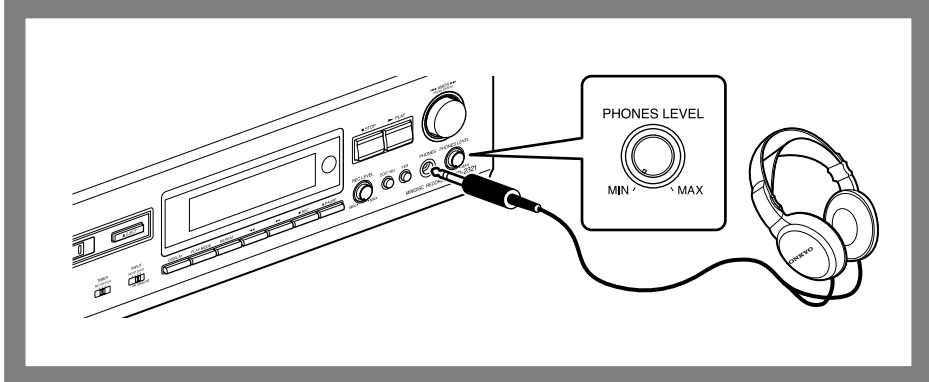

Listening with headphones

Plug the headphones into the PHONES jack and adjust the sound level using the PHONES-LEVEL knob.

- Turn the knob clockwise to increase the sound level; turn it counterclockwise to decrease the sound level.

Playing an MD

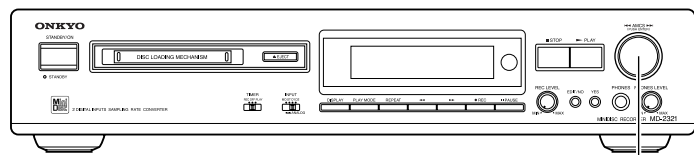

◀◀ AMCS ▶▶

RC-339MD

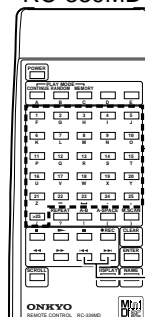

Number buttons

◀◀ , ▶▶

Remote controller

1	2	3	4	5
F	G	H	I	J
6	7	8	9	10
K	L	M	N	O
11	12	13	14	15
P	Q	R	S	T
16	17	18	19	20
U	V	W	X	Y
21	22	23	24	25
Z	-	-	-	-
>25	REPEAT	A-B	A-SPACE	M.SCAN
/	?	!	()

TRACK 0 0n10s

DIGITAL IN 1

L ■■■■■■ -00-40 -20 -10 -6 -2 0

R ■■■■■■

11 12 13 14 15 >15

Selecting a playing track using the number buttons

Press the number button on the remote controller to select the track you want to play.

Note:

To play a track numbered 26 or more...

Press the [>25] button first. Set a value for the 10th place and then the 1st place using the number buttons in this order. (You can enter "0" by pressing the [10] button.)

Ex.

To select the 30th track:

[>25] + [3] + [10]

To select the 100th track:

[>25] + [>25] + [1] + [10] + [10]

The [>15] indicator lights up during playback of a track numbered 16 or higher.

◀◀ AMCS ▶▶ (PUSH ENTER)

Remote controller

Changing the playing track using the AMCS

During play, you can change the playing track by turning the AMCS knob (or by pressing the ◀◀ and ▶▶ buttons on the remote controller).

If the MD recorder is stopped, turn the AMCS knob to select the track number you wish to play, and press the knob. (On the remote controller, use the ◀◀ or ▶▶ button to select the track, then press the ▶ button.)

To play the next track or a later track...

Turn the AMCS knob clockwise (or press the ▶▶ button on the remote controller several times) until the desired track is located.

To start playback again from the beginning of a track that is currently playing, or to play the previous track or an earlier track...

Turn the AMCS knob counterclockwise (or press the ◀◀ button on the remote controller several times) until the desired track is located.

In Memory playback mode (see page 19), turn the AMCS knob (or press the ◀◀ or ▶▶ button) to select tracks in the stored sequence.

Playing an MD

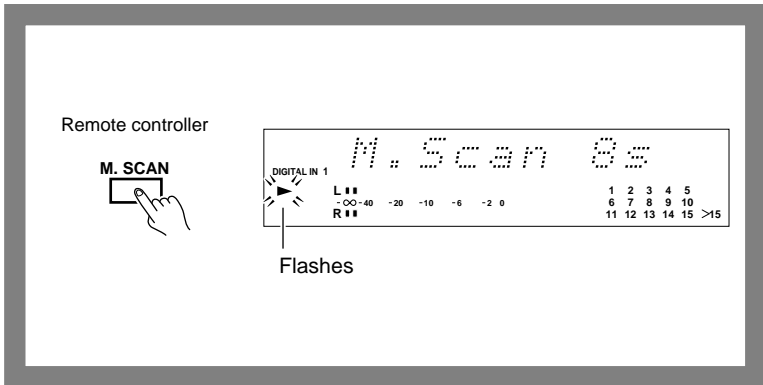
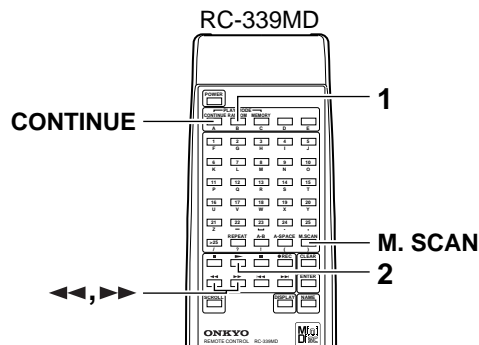
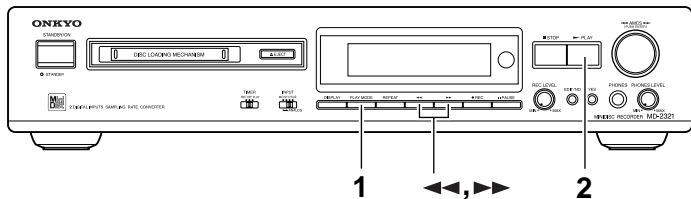

Music Scan

The following function is available only when you use the remote controller.

When you press the M.SCAN button while the MD recorder is either playing or stopped, the beginning (eight seconds) of each track on the disc is played back in sequence.

The ► indicator flashes during music scan.

Press the ► or M.SCAN button on the remote controller while the beginning of a track is playing to continue playing back the track.

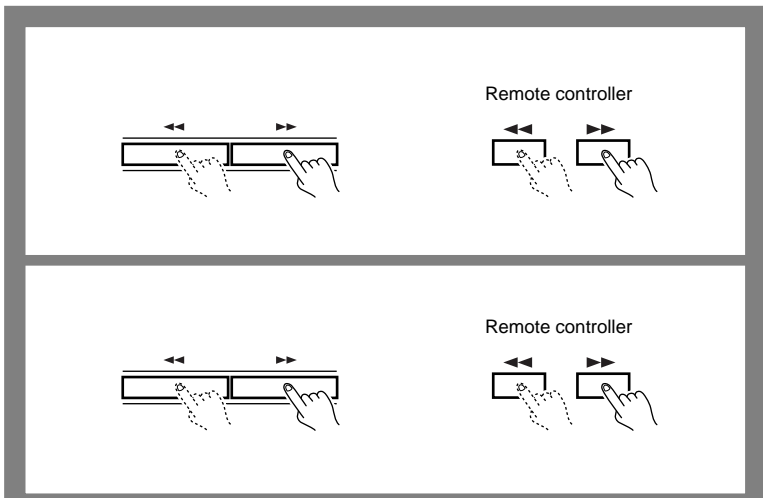

Searching for a part to play (Search playback)

Searching for a part to play by cueing

During playback, hold down the ◀◀ or ▶▶ button and release it when the part you want to hear starts to play.

Searching for a part to play using the time display (at pause, high-speed search)

When playback is temporarily stopped (paused), keep pressing the ◀◀ or ▶▶ button and release it when the playing time of the part you want to hear is displayed. Press the ► PLAY button (or the ► button on the remote controller) to start playing from that position.

Note:

- “Over” indicates that the end of the last track has been reached.

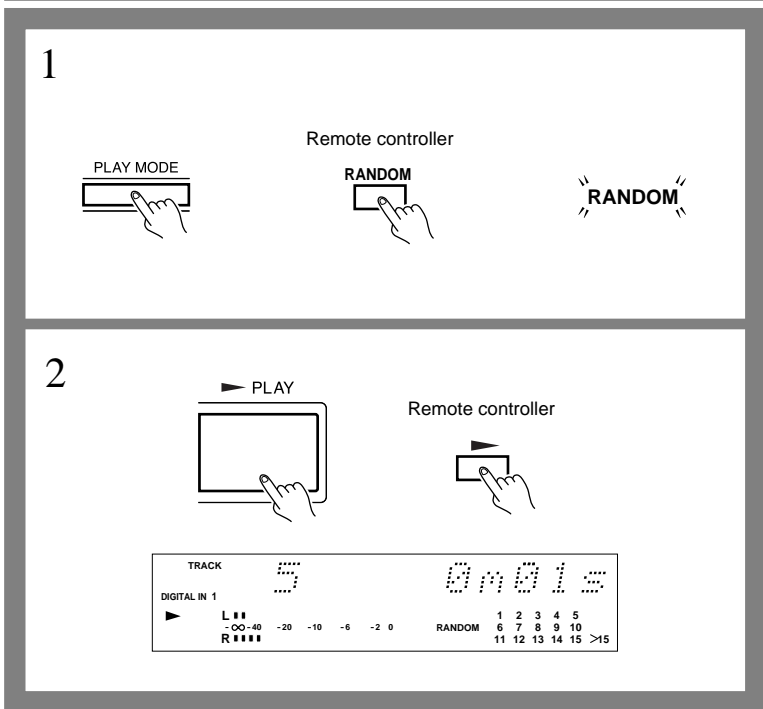

Playing tracks in random order (Random playback)

1. When the MD recorder is stopped, press the PLAY MODE button several times until “RANDOM” appears on the display.

The display changes as shown below each time you press the PLAY MODE button:

Random playback (RANDOM indicator lights up.)

↓
Memory playback (MEMORY indicator lights up.)

↓
Normal playback (No indicator appears.)

To select random mode using the remote controller, press the RANDOM button.

2. Press the ► PLAY button (or the ► button on the remote controller).

To exit random mode

When the MD recorder is stopped, press the PLAY MODE button several times until “RANDOM” disappears from the display. (Or, press the CONTINUE button on the remote controller.)

Playing an MD

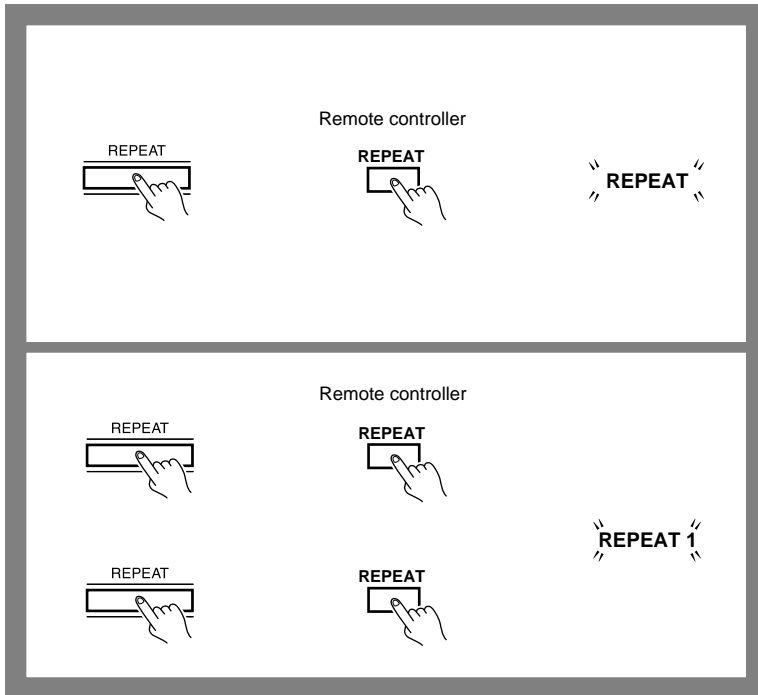
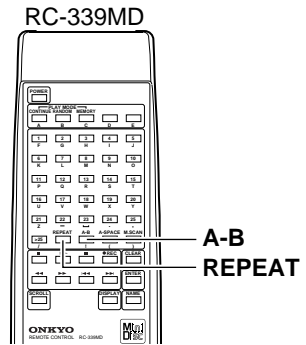
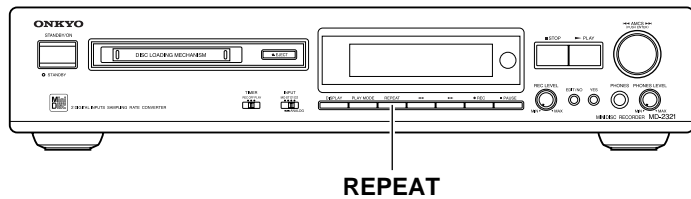

Playing a track(s) or desired section repeatedly

To play all tracks on the disc repeatedly, press the REPEAT button once.

- If you press the REPEAT button during Memory playback...
Only the programmed tracks will be played repeatedly in the programmed order.
- If you press the REPEAT button during Random playback...
The contents of the entire disc will be repeatedly played in random order.

To play the current track repeatedly, press the REPEAT button twice.

Note:

In Memory Playback or Random Playback, you cannot repeat the currently-playing track. (The "REPEAT 1" function does not work.)

To stop the repeat...

Press the REPEAT button once or twice until the "REPEAT" indicator disappears.

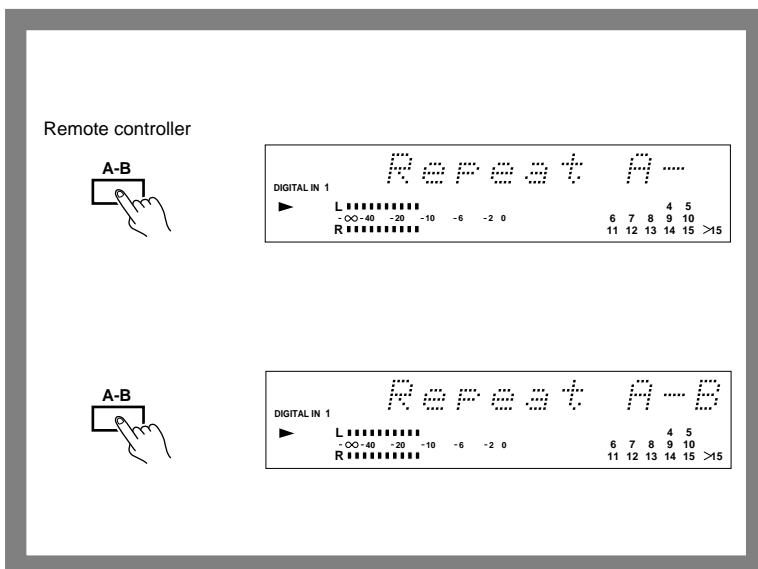

To repeat the desired section of a track...

1. While the track is playing, press the A-B button on the remote controller to specify the beginning of the section you wish to repeat playing (Point A).
2. While the track is still playing, press the A-B button again to specify the end of the repeat section (Point B). The section between A and B of the track will repeat.

NOTE:

- You cannot specify the repeat section over two or more consecutive tracks.
- After you set Point A, if the song reaches the end before you set Point B, the Point A setting is cancelled and normal playback resumes.

To stop the repeat of the section...

Press the REPEAT button several times until the "REPEAT" indicator disappears. Alternatively, press the ■ button or A-B button.

Recording to an MD

Digital recording technique uses an optical digital cable to input signals from a digital recording source.

- This MD recorder contains a sampling frequency rate converter for digital input signals which converts the sampling frequency of digital input signals to 44.1 kHz before recording.

This converter can handle the following sampling frequencies:

- 44.1 kHz (CD player)
- 32 kHz (DAT, satellite broadcasting)
- 48 kHz (DAT, satellite broadcasting)

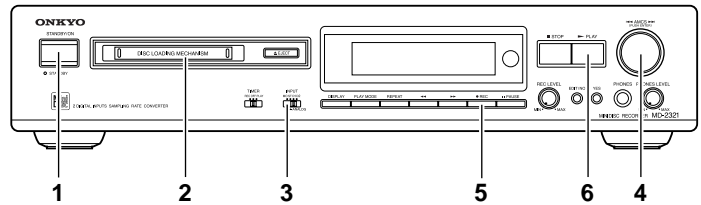

1

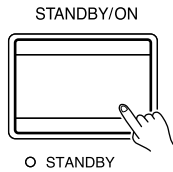

2

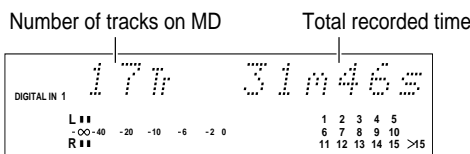
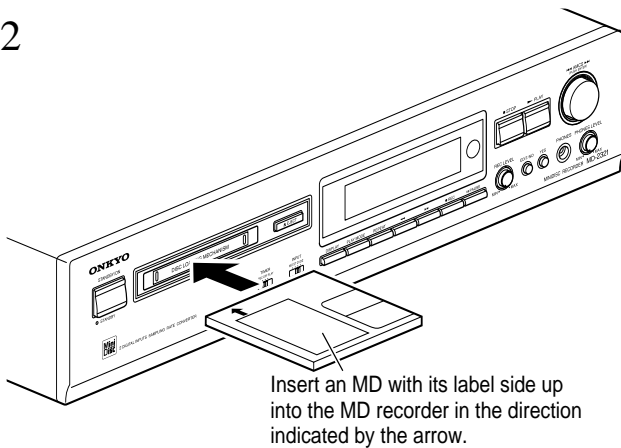

3

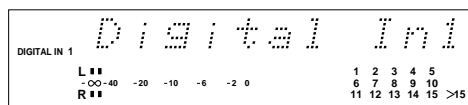
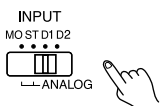

4

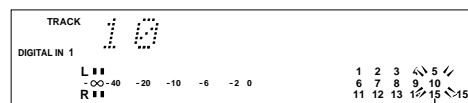
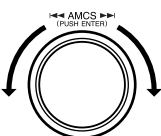

Flashes

Recording from a digital source

- Press the STANDBY/ON button.**
The STANDBY indicator will turn off.
- Load a recordable MD.**
To check the time remaining for recording...
When the MD recorder is stopped, press the DISPLAY button. Each press of the DISPLAY button changes the display as follows:
The number of tracks on the disc and the total recorded time → Available recording time on the disc → Disc name ("No Name" appears if the disc is not named.)
- Set the INPUT selector to the "D1" or "D2" position.**
D1: Select this if you have connected the recording source equipment to DIGITAL INPUT 1 (OPTICAL).
D2: Select this if you have connected the recording source equipment to DIGITAL INPUT 2 (COAXIAL).
Note:
Make sure which of the digital input terminals the supplied optical cable is connected to. If you attempt to perform digital recording using a digital input terminal that is not connected, "D.In Unlock" will appear.
- Select the position (track number) on the disc at which you wish to start recording.**
 - To record while erasing the existing tracks on the disc...**
Turn the AMCS knob to select the track number from which you wish to start recording. (The selected track number will flash.) The MD recorder will record new data while erasing the selected track and subsequent tracks.
 - To record by erasing all existing tracks on the disc...**
Select Track 1 via the AMCS knob or after erasing the entire contents of the disc. (See "Erasing a track" on page 20.)
If a new disc is used for recording, or if you wish to record over the existing track(s) on the disc, ignore this step and proceed to step 5.

Recording to an MD

5

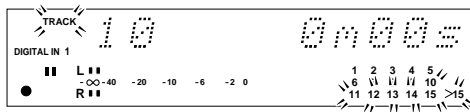
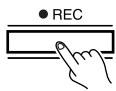

6

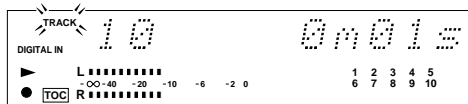
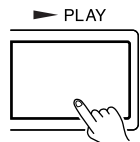

If you stop recording while erasing the songs that follow the specified song (overwrite recording), the unerased part will be recorded as a new track. During overwrite recording, the “TRACK” indicator lights up.

When you start recording from the top of a song

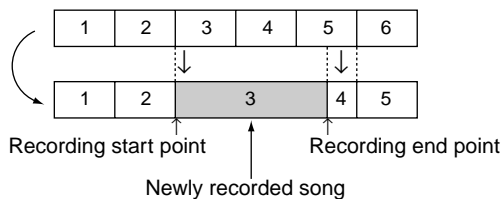

When you start recording in the middle of a song

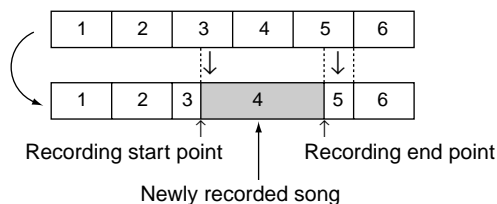

5. Press the ● REC button.

The MD recorder is now in recording standby mode.

- If “Protected” appears on the display, the record-protect tab of the MD is open. Before starting the recording procedure, close the tab. (See page 18.)

If “D. In Unlock” appears...

The digital input source is not connected properly. Check the connection of the digital input source.

When you record while erasing existing data, the “TRACK” indicator and the number indicators of the track selected in Step 4 and subsequent tracks flash.

6. Press the ► PLAY button and start playing the recording source immediately.

The MD recorder will automatically stop when the recordable time on the disc expires.

If the Rec source is “CD” or “MD”, track numbers are recorded automatically.

Note:

For automatic track number recording, the recording source must be able to transmit digital signals, including those for identifying the beginning and end of each track. If your recording source does not have this capability, track numbers will not be recorded automatically. In this case, turn the Level Sync On.

To manually record a track number...

While recording, press the ● REC button when you wish to mark a track number.

If you wish to mark two or more track numbers sequentially, provide a sufficient interval between each press of the ● REC button. Too short (about 4 seconds or less) an interval may lead to a failure in marking track numbers.

To stop recording temporarily...

Press the || PAUSE button (or the || button on the remote controller). To resume recording, press the ► PLAY button again (or press the ► button on the remote controller).

To stop recording...

Press the ■ STOP button.

To eject the MD...

Press the ■ button, then the ▲ EJECT button.

Caution:

The [TOC] indicator flashes: If you press the ▲ button or the STANDBY/ON button while the MD recorder is still writing the recorded contents onto the disc. During this period, do not disconnect the power cord or allow the MD recorder to vibrate. Doing so may prevent normal recording onto the MD.

If the MD recorder’s power cord is connected to the SWITCHED service power outlet on the rear panel of another device, do not turn off the power to the device.

If you cannot record combined data (page 13) successfully, switch to analog recording (page 14).

Auto Cut

Smart Space

Useful functions for digital recording

If “Auto Cut” appears during digital recording...

This message appears if the MD-2321 detects more than 30 seconds of silence on the source during digital recording. If this occurs, the MD recorder will stop recording and enter recording standby mode after recording about five seconds of silence on the disc.

To resume recording, press the ► button.

If “Smart Space” appears during digital recording...

This message appears if three to thirty seconds of silence in the source is encountered during digital recording. If this occurs, the MD recorder will insert about five seconds of silence and standby to record the subsequent sound.

Recording to an MD

Analog recording technique uses audio connection cables to input signals from the recording source.

- If “Protected” appears on the display, the record-protect tab of the MD is open. Before you start the recording procedure, close the tab. (See page 18.)
- Data is recorded after the already-recorded area unless you specify a recording start point.

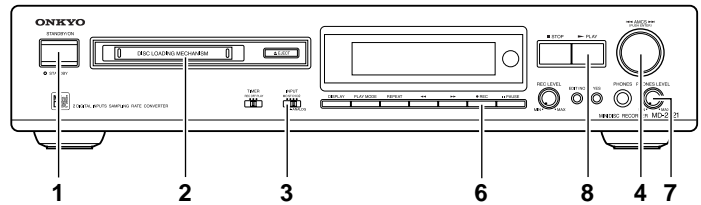

1

STANDBY/ON

○ STANDBY

2

Insert an MD with its label side up into the MD recorder in the direction indicated by the arrow.

Number of tracks on MD Total recorded time

DIGITAL IN 1 177 31m46s

L ■ ■ -∞ -40 -20 -10 -6 -2 0	1 2 3 4 5 6 7 8 9 10 11 12 13 14 15 >15
R ■ ■	

3

INPUT
MO ST D1 D2

← ANALOG

ANALOG IN A. In Stereo

L ■ ■ -∞ -40 -20 -10 -6 -2 0	1 2 3 4 5 6 7 8 9 10 11 12 13 14 15 >15
R ■ ■	

4

← AMCS →
(PUSH SYSTEM)

TRACK
ANALOG IN 10

L ■ ■ -∞ -40 -20 -10 -6 -2 0	1 2 3 4 5 6 7 8 9 10 11 12 13 14 15 >15
R ■ ■	

Flashes

6

● REC

TRACK
ANALOG IN 10 0m00s

L ■ ■ -∞ -40 -20 -10 -6 -2 0	1 2 3 4 5 6 7 8 9 10 11 12 13 14 15 >15
R ■ ■	

Recording from an analog source

- 1. Press the STANDBY/ON button.**
The STANDBY indicator will turn off.
- 2. Load a recordable MD.**
To check the time remaining for recording...
When the MD recorder is stopped, press the DISPLAY button. Each press of the DISPLAY button changes the display as follows:
The number of tracks on the disc and the total recorded time → Available recording time on the disc → Disc name (“No Name” appears if the disc is not named.)
 - If “Protected” appears on the display, the record-protect tab of the MD is open. Before you start the recording procedure, close the tab. (See page 18.)
- 3. Set the INPUT selector to the “Analog”, “MO (monaural)” or “ST (stereo)” position.**
The input source is now set to “Analog”.
Monaural recording enables you to record about twice the duration of stereo recording.
Note:
 - Make sure that the INPUT selector on the MD-2321 and the REC selector on the amplifier are set to an appropriate recording source.
 - Do not change the INPUT selector setting during recording.
- 4. Select the position (track number) on the disc at which you wish to start recording.**
 - **To record while erasing the existing tracks on the disc...**
Turn the AMCS knob to select the track number from which you wish to start recording. (The selected track number will flash.) The MD recorder will record new data while erasing that track and subsequent tracks.
 - **To record by erasing all existing tracks on the disc...**
Select Track 1 via the AMCS knob or after erasing the entire contents of the disc. (See “Erasing a track” on page 20.).
If a new disc is used for recording, or if you wish to record over the existing track(s) on the disc, ignore this step and proceed to step 5.
- 5. Play the recording source.**
- 6. Press the ● REC button.**
The MD recorder is now in recording standby mode.
When you record while erasing already-existing data, the “TRACK” indicator and the number indicators for the track selected in Step 4 and the subsequent tracks flash.

Recording to an MD

7

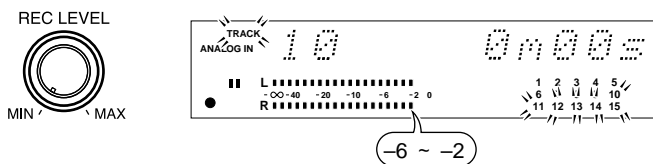

8

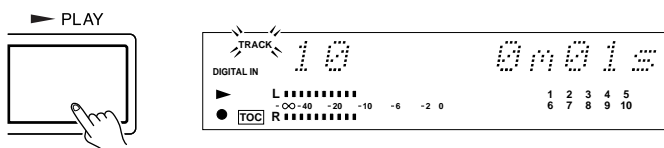

1

EDIT/NO

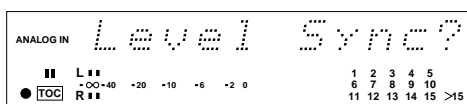

2

YES

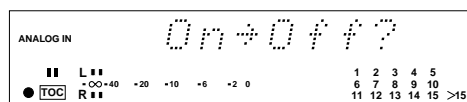

3

YES

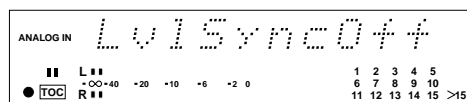

7. Using the REC LEVEL knob, adjust the recording level.

Adjust the position of the REC LEVEL knob so that the indicator occasionally enters the -6 to -2 dB range. When adjustment of the recording level is complete, stop playing the source.

8. Press the ▶ PLAY button to start recording on the MD-2321 and start playing the recording source immediately.

The TOC indicator appears as soon as recording starts. The MD recorder will automatically stop when recordable time on the disc expires.

The track numbers are recorded automatically.

Since the interval between tracks is detected based on the sound level, some tracks may not be numbered correctly in the following cases:

- Recorded condition of the cassette tape is bad (noise between tracks).
- Low sound level in quiet music.
- Interval between tracks is extremely short.
- Tuner's reception is bad (noise).

To disable this function refer to the explanation below on this page.

To manually record a track number

While recording, press the ● REC button when you wish to mark a track number.

If you wish to mark two or more track numbers sequentially, provide a sufficient interval between each press of the ● REC button. Too short (about 4 seconds or less) an interval may lead to a failure in marking track numbers.

To stop recording temporarily...

Press the || PAUSE button (or the || button on the remote controller). To resume recording, press the ▶ PLAY button again (or press the ▶ button on the remote controller).

To stop recording...

Press the ■ STOP button.

To eject the MD...

Press the ■ STOP button, then the ▲ EJECT button.

Caution:

The [TOC] indicator flashes: If you press the ▲ button or the STAND-BY/ON button while the MD recorder is still writing the recorded contents onto the disc. During this period, do not disconnect the power cord or allow the MD recorder to vibrate. Doing so may prevent normal recording onto the MD.

If the MD recorder's power cord is connected to the SWITCHED service power outlet on the rear panel of another device, do not turn off the power to the device.

To disable the automatic track numbering function...

Perform the following steps prior to Step 2 or Step 6:

1. Press the EDIT/NO button.
"LevelSync?" appears on the display.
2. Press the YES button.
If the function is currently turned on, "On→Off?" appears on the display.
3. Press the YES button.
"Lvl5yncOff" appears on the display.
Now the tracks will not be numbered during recording.
 - Press the EDIT/NO button any time if you wish to cancel the setting.

To enable the automatic track numbering function...

Perform the following steps prior to Step 2 or Step 6:

1. Press the EDIT/NO button.
"LevelSync?" appears on the display.
2. Press the YES button.
If the function is currently turned off, "Off→On?" appears on the display.
3. Press the YES button.
"Lvl5yncOn" appears on the display.

Recording to an MD

Synchro recording

If you connect an Onkyo **RI**-compatible device to the MD-2321, you can start recording on the MD recorder by pressing one button on the connected device, or start recording on the connected device by pressing one button on the MD recorder. This operation is possible when the recording device is in record standby mode.

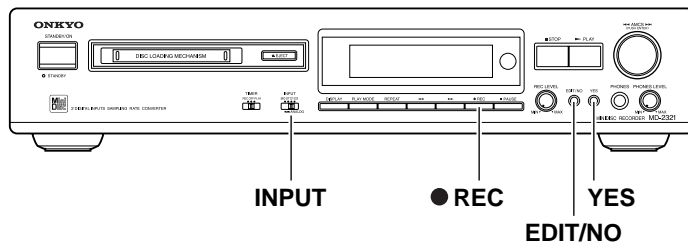

1

2

(Onkyo CD player bearing the RI mark)

(MD-2321)

CD Synchro recording

When your MD-2321 is configured into a system with an ONKYO CD player bearing the **RI** mark, you can operate the MD recorder and synchronize with the CD player.

1. **Set the MD recorder to recording standby mode.**
Refer to "Recording from an analog source" on pages 14 and 15 or "Recording from a digital source" on pages 12 and 13 for more information on how to set the MD recorder to recording standby mode and prepare it for recording.
- For digital CD Synchro recording.**
Connect the CD player's (optical or coaxial) digital output terminal to the MD-2321's DIGITAL INPUT.
2. **Start playing the CD.**
The unit starts recording as soon as the CD starts playing. If your cassette deck is also in recording standby mode, it starts recording simultaneously. When playback of the CD is complete, the MD recorder stops recording and enters recording standby mode.

To stop CD Synchro recording...
Press the button on the CD player. The MD recorder then enters recording standby mode.

Note:
For analog recording, set the input selector of the amplifier to "CD." If you change the input selector to a different setting during recording, the MD recorder will stop recording and enter recording standby mode.

1

Digital In1

2

Signal Rec?

3

Complete

↓

Signal Wait ↔ On00s

Signal Synchro recording

Even if your recording source is a portable MD player or not Onkyo **RI**-compatible player, you can still perform synchronized recording. Signal-synchronized recording records data from the end of the recorded area. The Auto Cut and Smart Space functions (page 13) are enabled only when analog input is recorded.

1. **Use the INPUT selector to select MO, ST, D1, or D2, according to the connected device.**
Analog connection: Select MO (monaural) or ST (stereo).
DIGITAL INPUT 1 OPTICAL connection: Select D1
DIGITAL INPUT 2 COAXIAL connection: Select D2.
You can perform Signal Synchro recording with both digital and analog recording sources.
2. **Press the EDIT/NO button repeatedly until "Signal Rec?" appears.**
3. **Press the YES button.**
"Complete" appears and the unit waits for signal input.

Note:
If "Signal Rec?" does not appear when you press the EDIT/NO button, first press the STOP button, then try again.
If no signal is input for approx. 30 seconds, the MD recorder will enter recording standby mode.

Recording starts as soon as the unit receives signals from the recording source while "Signal Wait" is displayed.

Recording to an MD

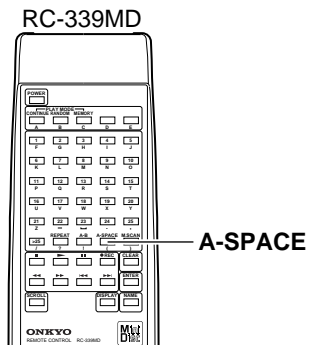
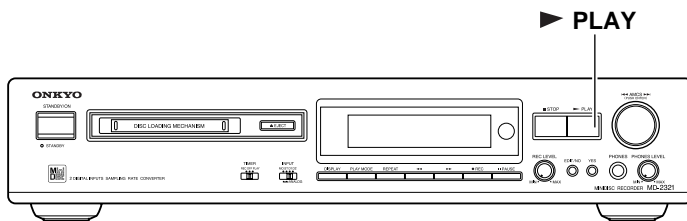

1

(Cassette Tape Deck)

2

Synchronized recording to a cassette tape deck (MD Synchro recording)

When the MD-2321 is configured into a system that includes an Onkyo cassette tape deck bearing the **RI** mark, synchronized recording from the MD recorder to the cassette tape deck is possible.

- 1. Insert a cassette tape in the cassette tape deck and set the cassette tape deck to recording standby mode.**
See the cassette tape deck instruction manual for more information on how to set the tape deck to recording standby mode.
- 2. Press the ► PLAY button on the MD recorder (or the ► button on the remote controller).**
The cassette tape deck starts recording as soon as the MD starts playing.
When the MD program is completed, the cassette tape deck stops recording and enters recording standby mode again.

To stop MD Synchro recording...

Press the ■ STOP button on the MD recorder. The cassette tape deck enters recording standby mode.

1

Remote controller

2

Remote controller

Using the Auto Space function

The Auto Space function automatically inserts three seconds of silence between tracks when you are recording data on another MD recorder or a connected cassette tape recorder. This function is useful, for example, when you want the auto track locate function of a cassette player to work properly.

- 1. Press the A-SPACE button on the remote controller.**
The current setting appears on the display (e.g., A-Space Off).
- 2. To revert to the previous setting, press the A-SPACE button again while the current setting is shown on the display.**
When you start recording, a silent section of about 3 seconds will be inserted between the recorded tracks.

To cancel the Auto Space function...

Follow Steps 1 and 2 above to select "A-Space Off".

Recording to an MD

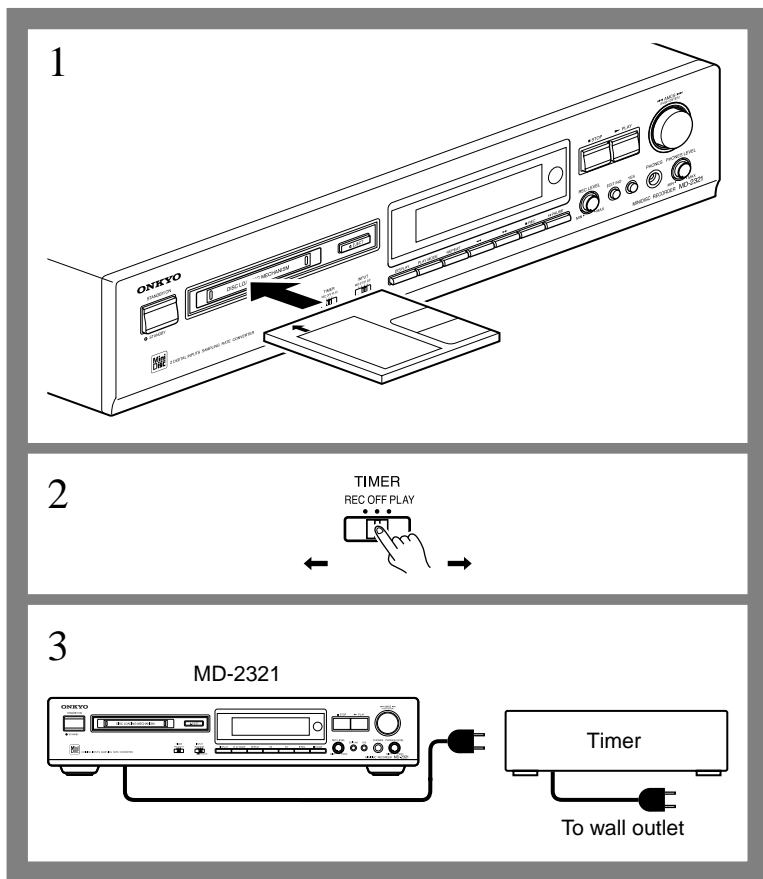

Using an audio timer

You can use a commercially available audio timer for recording and playing.

1. **Load an MD.**
 - If the disc contains recorded material, new data will be recorded following the existing tracks.
2. **Set the TIMER switch on the MD-2321 to “REC” for recording or “PLAY” for playback.**
 - Set the audio timer approximately one minute earlier than actual recording start time. The MD recorder may require some time to write and read the TOC information after it is activated by the timer.
 - Refer to the accompanying instruction manual for information on how to set your audio timer.
3. **Plug in the AC power cord of the MD-2321 to the audio timer.**
 - If the MD becomes full during recording, recording stops immediately and the MD recorder enters STAND-BY mode.

Note:

After using the audio timer for recording, be sure to energize the MD recorder (by plugging in its AC power cord to a wall outlet or the UNSWITCHED outlet of another system component) for two or three days. If the MD recorder is not energized sufficiently after the audio timer recording, the recorded materials may be lost.

Checking the contents of recording

- When recording is completed the first recorded track number flashes. Press the ► PLAY button to start playing the track.
- To play from the beginning of the MD immediately after recording is stopped, press the ■ STOP button again. Then, press the ► PLAY button (or the ► button on the remote controller) to start playback.

Storage period for backup data

The recorded contents will be backed-up inside the MD-2321 even if the MD recorder’s power cord is accidentally unplugged or if a power failure occurs before (when **TOC** is lit) or while (when **TOC** is flashing) the contents are being stored to disc. You can restore data that was backed up during such an accident or power failure by pressing the STANDBY/ON button after plugging in the power cord or immediately after the power failure is solved. Note, however, that the MD-2321 can maintain data in the backup memory for approximately an hour. We recommend that after a power failure, you perform the above procedure immediately after the power is restored.

If the power continues to be down for one hour or more, recorded contents may be lost.

Protecting recordings from accidental erasure

You can prevent your MDs from being recorded. Slide the record-protect tab on an MD to open the slot. To make the MDs recordable again, slide back the record-protect tab to close the slot.

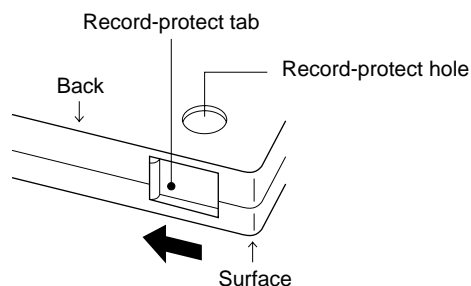

Using the program function (memory play)

- You can program up to 25 tracks.
- If the total playing time of the programmed tracks exceeds 1000 minutes, the MD-2321 displays “---m--s”.
- Too short a song cannot be programmed. (“Too Short” appears.)

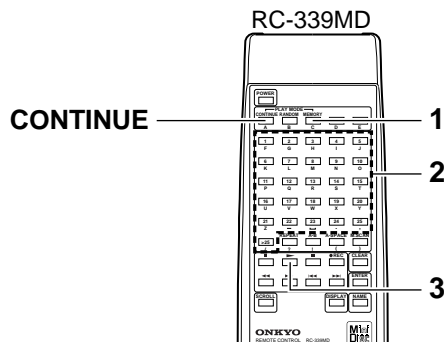
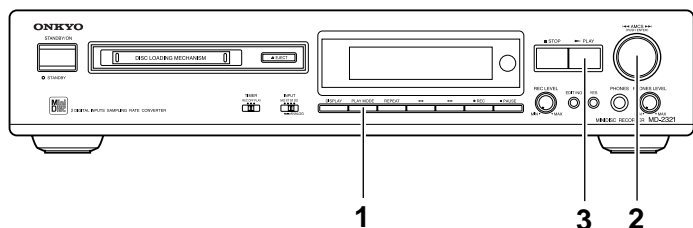

1

PLAY MODE

Remote controller
MEMORY

MEMORY

2

AMCS knob (CLOCKWISE)

AMCS knob (COUNTER-CLOCKWISE)

Remote controller

1	2	3	4	5
F	G	H	I	J
6	7	8	9	10
K	L	M	N	O
11	12	13	14	15
P	Q	R	S	T
16	17	18	19	20
U	V	W	X	Y
21	22	23	24	25
Z				
>25	REPEAT	A-B	A-SPACE	M.SCAN
/	?	!	()

TRACK 0

DIGITAL IN 1 L ■ ■ ■ -∞-40 -20 -10 -6 -2 R ■ ■ ■ MEMORY

Programmed track number

TRACK 4 Step01

DIGITAL IN 1 L ■ ■ ■ -∞-40 -20 -10 -6 -2 0 R ■ ■ ■ MEMORY 4

Total playing time of programmed tracks

TRACK 4 5m10s

DIGITAL IN 1 L ■ ■ ■ -∞-40 -20 -10 -6 -2 0 R ■ ■ ■ MEMORY 4

Programmed track

3

PLAY

Remote controller

Playing track number

TRACK 4 0m01s

DIGITAL IN 1 L ■ ■ ■ -∞-40 -20 -10 -6 -2 0 R ■ ■ ■ MEMORY 4

PLAY indicator

1. When the MD recorder is stopped, press the PLAY MODE button several times until “MEMORY” appears on the display,

Alternatively, press the MEMORY button on the remote controller.

2. Using the AMCS knob, select the tracks in the order you want to play.

Turn the AMCS knob until the track number you want to program appears (the track playing time is displayed). Press the AMCS knob to program the track.

To play a track numbered 26 or higher...

Press the [>25] button first. Use the numeric buttons to set a value for the 10th place, then the 1st place. (Press the [10] button to enter “0”.)

E.x.,

To select the 30th track

[>25] + [3] + [10]

To select the 100th track

[>25] + [>25] + [1] + [10] + [10]

3. Press the ► PLAY button (or the ► button on the remote controller) to start Memory playback.

When the playback of all programmed tracks concludes, the MD recorder stops. The programmed tracks are retained in memory.

To exit Memory playback mode:

When the MD recorder is stopped, press the PLAY MODE button several times until “MEMORY” disappears from the display. (Or, press the CONTINUE button on the remote controller.)

All data in the memory will be erased.

Clearing the last track stored:

Press the ■ or CLEAR button on the remote controller.

The last track programmed in memory is cleared.

Re-programming:

Cancel the program setting, then repeat the procedure from Step 2.

Editing the contents of an MD

The MD-2321 features various editing functions that enable you to erase tracks, divide or combine tracks, and move a track to a new location on the disc.

Note that you cannot edit the contents of premastered MDs.

Also, you cannot edit the disc if its record-protect slot is open (i.e., "Protected" is displayed).

Before starting the editing procedure, close the slot. (See page 18.)

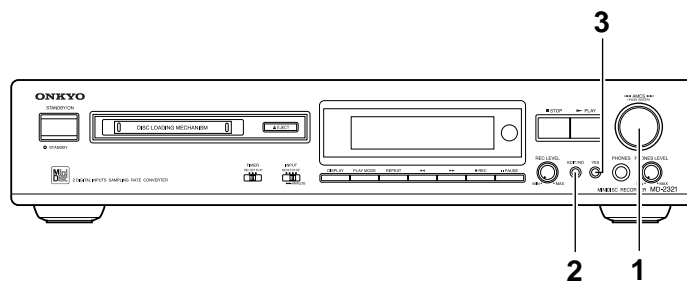

1

Track number

2

3

Lights when completed.

Erasing a track

Perform the following steps to erase a track while the unit is stopped or paused.

1. Turn the AMCS knob until the track number you want to erase is displayed.

2. Press the EDIT/NO button several times until "Erase?" appears on the display.

- To cancel the operation... Press the EDIT/NO button again, or press the ■ STOP button.

3. Press the YES button. The selected track is erased. When the track is erased, "Complete" appears on the display.

- When a track is erased, the subsequent track numbers advance. For example, if you erase track 2, track 3 is renumbered as track 2; track 4 is renumbered as track 3, and so on.

Note:

While the TOC indicator is lit or flashing, do not move or unplug the MD recorder.

To erase all tracks on an MD...

1. Press the ■ STOP button.

2. Press the EDIT/NO button several times until "All Erase?" appears on the display.

To cancel the operation, press the EDIT/NO button or the ■ STOP button.

3. Press the YES button. "All Erase??" appears for confirmation.

The track number flashes on the display.

4. Press the YES button again.

When all tracks on the MD are erased, "Complete" followed by "Blank Disc" appears on the display.

Note:

- To erase part of a track, first divide the track into parts, then erase the part. (See page 21 for more information on how to divide tracks.)

- While the TOC indicator is lit or flashing, do not move or unplug the MD recorder.

Editing the contents of an MD

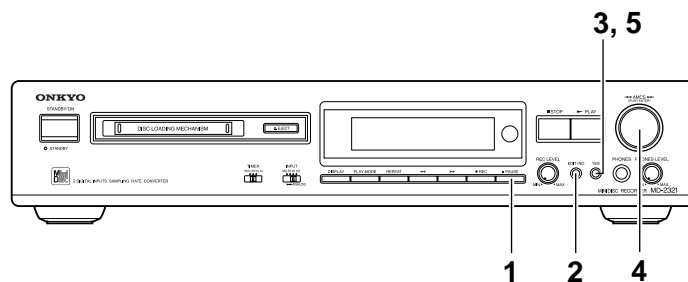

1

2

3

4

5

Lights when completed.

Dividing a track

1. During playback, press the **|| PAUSE** button at the point where you wish to divide the track.
2. Press the **EDIT/NO** button several times until “Divide?” appears on the display.
 - To cancel the operation... Press the EDIT/NO button again, or press the **■ STOP** button.
3. Press the **YES** button. The MD recorder repeatedly plays a part approximately four seconds before and after the dividing point. “Rehearsal” and “Position OK?” alternately flash on the display.
4. Turn the **AMCS knob** while listening to the part being played to fine-adjust the point where you wish to divide the track. The dividing point is represented by 0.5 seconds of silence. You can move the dividing point in the range of -128 to +127. (One step corresponds to approximately 0.06 seconds.)
5. Press the **YES** button or **AMCS knob** to execute the operation. After the track is divided, “Complete” appears on the display.
 - When a track is divided, the subsequent tracks are renumbered accordingly. For example, if you divide track 2 into two parts, the latter part is renumbered as track 3; track 3 is renumbered as track 4; track 4 is renumbered as track 5, and so on.

Note:
While the TOC indicator is lit or flashing, do not move or unplug the MD recorder.

Editing the contents of an MD

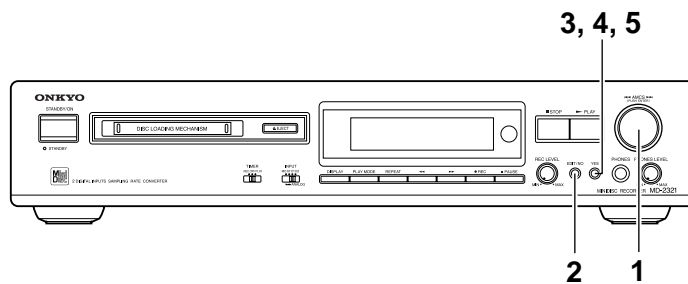

1

2

TRACK		9 Combine?											
DIGITAL IN 1													
L	■	-∞	-40	-20	-10	-6	-2	0	1	2	3	4	5
R	■								11	12	13	9	10

3

Rehearsal ↔ Track OK?

4

DIGITAL IN 1		Complete												
TOC														
L	■	-∞	-40	-20	-10	-6	-2	0				8	9	10
R	■								11	12	13			

Lights when completed.

Combining tracks

You can combine two adjacent tracks into one. Note, however, that you cannot combine an analog monaural track with another type of track (e.g., recorded via analog stereo, Digital 1, Digital 2). This function is available while the unit is stopped, paused or playing.

1. Turn the AMCS knob to select the larger number of the two adjacent tracks you wish to combine.

- If both tracks have titles, the first track's title will be used for a combined track.
- If only the first track has a title, that title will be used.
- If only the latter track has a title, that title will be erased.

2. Press the EDIT/NO button several times until "Combine?" appears on the display.

- **To cancel the operation...**
Press the EDIT/NO button again, or press the ■ STOP button.

3. Press the YES button again.
The part at which the two tracks are to be combined plays (for 8 seconds) repeatedly, with "Rehearsal" and "Track OK?" alternately showing on the display.

4. Press the YES button to combine the tracks you have selected.

When the tracks are combined, "Complete" appears on the display, and the subsequent track numbers advance. For example, if you combine track 3 with track 2, track 4 is renumbered as track 3; track 5 is renumbered as track 4, and so on.

Note:
While the TOC indicator is lit or flashing, do not move or unplug the MD recorder.

Editing the contents of an MD

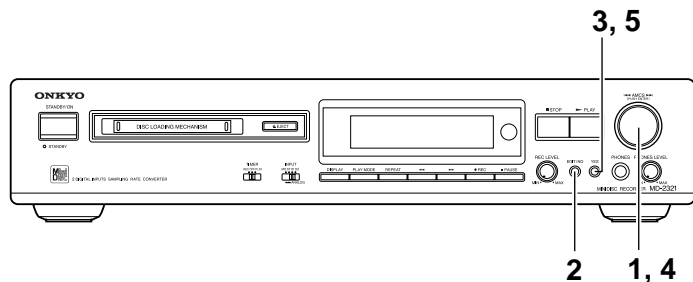

1

2

TRACK 6 Move?

DIGITAL IN 1

L ■ ■ -∞ -40 -20 -10 -6 -2 0

R ■ ■

2 3 4 5

6 7 8 9 10

11 12 13 14

3

TRACK Move# 6+1?

DIGITAL IN 1

L ■ ■ -∞ -40 -20 -10 -6 -2 0

R ■ ■

2 3 4 5

6 7 8 9 10

11 12 13 14

4

TRACK Move# 6+3?

DIGITAL IN 1

L ■ ■ -∞ -40 -20 -10 -6 -2 0

R ■ ■

2 3 4 5

6 7 8 9 10

11 12 13 14

5

DIGITAL IN 1 Complete

L ■ ■ -∞ -40 -20 -10 -6 -2 0

R ■ ■

1 2 3 4 5

6 7 8 9 10

11 12 13 14

Lights when completed.

Moving a track

This function is available while the unit is stopped or paused.

1. Turn the AMCS knob until the track number you want to move appears on the display.
2. Press the EDIT/NO button several times until "Move?" appears on the display.
3. Press the YES button.
4. Turn the AMCS knob to select the desired destination track number.
5. Press the YES button or AMCS knob to execute the operation.

When the track is moved, "Complete" appears on the display, and the tracks are renumbered accordingly. For example, if you move track 3 to track 1, the original track 1 is renumbered as track 2; track 2 is renumbered as track 3, and so on.

Note:
While the TOC indicator is lit or flashing, do not move or unplug the MD recorder.

Naming a track or disc

You can name tracks and discs using the AMCS knob on the front panel or the character buttons on the remote controller. You may name tracks at any time. However, the MD-2321 must be stopped when you name a disc.

You can enter up to 100 characters for each track name and a disc title. The characters being entered are cancelled if the playing or recording track is changed.

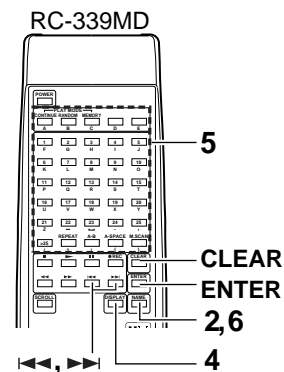
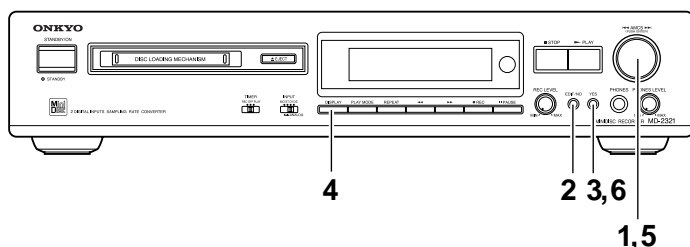

1 To name a disc

↓

To name a track

↻ AMCS (PUSH ENTER) ↻

2

Remote controller

3

YES

4

Remote controller

Naming a track or disc

1. Turn the AMCS knob to select a track you wish to name.

- To name a disc, skip step 1 and go to step 2.

Note:

If you wish to name a track while recording or playing it, start with Step 2 below during recording or playback. Note that if recording or playback is complete before you finish entering the entire name, the characters you input so far will be cancelled.

2. Press the EDIT/NO button several times until “Name In?” appears on the display.

Alternatively, press the NAME button on the remote controller. (In this case, the “Name In?” display will be skipped.)

When you name a track, the TRACK indicator will turn on.

To cancel the operation...

Press the ■ STOP, or press the YES button while pressing and holding down the EDIT/NO button.

3. Press the YES button.

A blinking cursor appears.

4. Press the DISPLAY button repeatedly to select a character input mode.

You can enter upper case letters, lower case letters, and numbers and symbols. Each press of the DISPLAY button changes the type of character you can enter as follows:

- Upper case letters (A, B, C...) ←
 - ↓
 - Lower case letters (a, b, c...)
 - ↓
 - Numbers and symbols (1, 2, 3...)
 - ↓
 - Easy title (♪)
- (Refer to the table below.)

Preset titles for easy titling

In Easy Titling mode, you can enter the following titles by simply choosing one.

BALLAD	ROCK	German	Heavy
BLUES	SOUL	Japanese	Hit songs
CLASSIC	TECHNO	Anthology	Omnibus
DANCE	VOCAL	Best of	Selection
FUSION	African	(One space will be added	Special
JAZZ	American	following “of”.)	Super
LIVE	Asian	Collection	Space ()
POPS	British	Favorite	
REGGAE	Euro	Happy	

Naming a track or disc

5

Remote controller

PLAY MODE				
CONTINUE	RANDOM	MEMORY		
A	B	C	D	E
1 F	2 G	3 H	4 I	5 J
6 K	7 L	8 M	9 N	10 O
11 P	12 Q	13 R	14 S	15 T
16 U	17 V	18 W	19 X	20 Y
21 Z	22 -	23 .	24 ,	25 _
>25 /	?	!	()

6

Remote controller

Lights when completed.

1

EDIT/NO

2

YES

Lights when completed.

5. Enter a track name or disc name using the AMCS knob.

Turn the AMCS knob to select a character and press the AMCS knob to enter it. Follow the same procedure to enter the entire name.

To enter a name using the remote controller...

You can enter numbers (1 to 9, 0 by the 10 button), upper-case and lowercase letters, and symbols (only those indicated below the buttons) using the remote controller.

Use the ◀◀ and ▶▶ buttons on the remote controller to select characters and press the ENTER button or the ▶▶ button to confirm the entry.

To change the type of characters entered...

Go back to step 4 and change the character input mode. Then, select and enter characters using the AMCS knob.

To correct the entered character...

Select the character you want to correct using the ◀◀ and ▶▶ buttons (the selected character blinks), then reenter the character you want.

To insert a character...

Select the character before which you want to insert a character using the ◀◀ and ▶▶ buttons (the selected character blinks).

Turn the AMCS knob counterclockwise (▶◀ blinks) and press the AMCS knob (the cursor blinks). Finally, enter the character you want.

To erase a character...

Select the character that you want to erase using the ◀◀ and ▶▶ buttons (the character blinks) and press the EDIT/NO button on the front panel or CLEAR button on the remote controller.

To insert a space...

Turn AMCS knob to display () and press the knob to set.

6. Press the YES button.

Alternatively, press the NAME button on the remote controller.

“Complete” appears on the display.

Note:

While the TOC indicator is lit or flashing, do not move or unplug the MD recorder.

Erasing the disc name and all track names at one time

1. Press the EDIT/NO button repeatedly to display “Name Erase?” while the MD-2321 is stopped.

Note:

Once the disc name and all track names are erased, they cannot be restored.

2. Press the YES button to erase all track names and the disc name, or press the ■ STOP button to cancel the operation.

Precautions for handling the MiniDisc (MD)

The MD is housed in a cartridge, so you can handle it without worrying about dust and fingerprints. Even so, a dirty or warped cartridge may cause malfunction. Always remember the following precautions so you can enjoy high-quality sound for a long time.

Do not touch the disc in the cartridge directly with your fingers. Do not open the shutter by hand. Doing so may damage the disc.

Storage location

Avoid storing MDs in a place subject to direct sunlight, high temperature, or high humidity.

When the unit is not to be used for an extended period

Remove the MD from the unit to avoid dust entering the MD cartridge. When the MD is in the unit, the shutter of the MD cartridge remains open.

Regular care

Wipe off dust and dirt accumulated on the cartridge surface using a dry cloth.

Removing a halfway-inserted MD

If the “self-rock function” is activated and the MD cannot be removed, push the MD further into the MD recorder and then press the ▲ button to remove the MD.

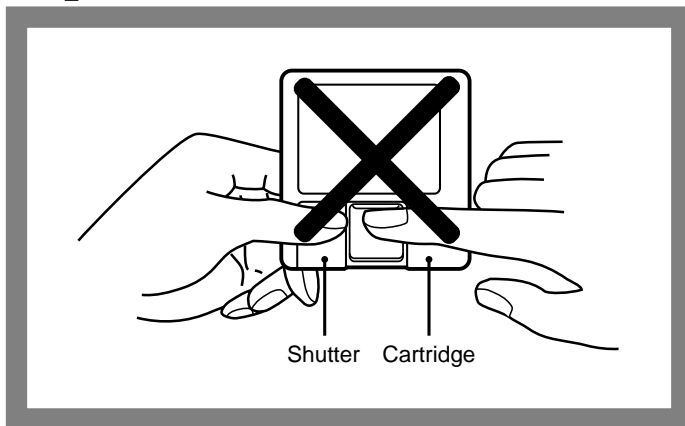

Message list

The following table explains the various messages that appear in the display.

Message	Meaning
All Erase!!	An attempt was made to record onto a faulty MD.
Blank Disc	A new recordable MD or a recordable MD without disc or track names is inserted.
Cannot Copy	An attempt was made to make a second copy from a digitally dubbed MD (see “Rules for Digital Recording” on page 28, 29).
Cannot Edit	An attempt was made to edit the disc during MEMORY or RANDOM play.
Cannot Rec	An attempt was made to record onto a premastered (read-only) disc.
D. In Unlock	The digital equipment (CD player, DAT, etc.) has not been connected properly.
Disc Error	The disc is abnormal (scratched or missing a TOC).
Disc Full	The disc is full (see “System Limitations” on page 29).
Impossible	The disc could not be edited.
Memory Full	An attempt was made to record a 26th track.
Name Full	The number of characters has reached the limit for input to one MD.
No Change	The disc or track name was not changed.
No Disc	There is no disc in the unit.
No Track	The inserted disc has a disc title but no tracks.
Over	In pause mode (when playing is paused), the ►► (Fast Forward) button was pressed to the end of the disc.
Protected	The inserted disc is record-protected.
Retry	The first recording attempt failed due to a disturbance or scratch on the MD, and a second recording is being made.
Retry Error	The recording attempt failed due to a consecutive disturbance or scratches on the MD.
Sorry	An attempt was made to combine tracks that cannot be combined or to divide a track at the beginning.

Troubleshooting guide

If you encounter difficulty while using your unit, use this troubleshooting guide as an aid to remedy the problem. Because the unit contains a microcomputer to provide advanced functions, it may malfunction due to external noise or static electricity. If this happens, disconnect the power cord and then plug it in again after about five seconds. You must also be sure that the system components are properly connected. If the MD recorder still does not operate correctly, disconnect the power plug, then plug it in again while pressing EDIT/NO button and YES button simultaneously.

Note that any TOC information held in this MD recorder will be erased by this operation.

If the problem persists even after you try this remedy, or if the problem is not listed in the table, disconnect the power cord and then consult the shop from which you purchased the unit or your nearest ONKYO service station, informing them of your name, address, phone number, type of unit, and the details of the problem.

- **The unit does not operate or operates poorly.**

Cause: The disc may be damaged (“Disc Error” appears).

Remedy: Take the disc out and insert it again. If “Disc Error” remains, replace the disc. (See page 26 “Precautions for handling the MiniDisc (MD)”)

- **The unit does not play.**

Cause: Moisture has formed inside the unit.

Remedy: Take the MD out and leave the unit in a warm place for several hours until the moisture evaporates (See below).

Cause: The unit is not on.

Remedy: Insert the AC power cord (main lead) plug into the wall outlet (the mains) securely.

Cause: The disc is inserted in the wrong direction.

Remedy: Slide the MD into the disc compartment with the label side up and the arrow pointing toward the opening until the unit grips the MD (See page 7).

Cause: The disc may not be recorded (the track numbers do not appear).

Remedy: Replace the disc with one that has been recorded.

- **The sound has a lot of static.**

Cause: Strong magnetism from a television or a similar device is interfering with operations.

Remedy: Move the unit away from the source of strong magnetism.

- **The unit does not record.**

Cause: The disc is record-protected (“Protected” appears).

Remedy: Close the record-protect slot (See page 18).

Cause: The unit is not connected properly to the sound source.

Remedy: Make connections properly to the sound source.

Cause: The analog recording level is too low.

Remedy: Turn the REC LEVEL control knob to adjust the recording level properly.

Cause: A premastered disc is inserted.

Remedy: Replace it with a recordable disc.

Cause: There is not enough time left on the disc.

Remedy: Replace it with another recordable disc with fewer recorded tracks.

Cause: There has been a power failure or the power cord has been disconnected.

Remedy: The contents of the recording may be lost permanently. After connecting the power cord or immediately after power has been restored, press the STANDBY/ON button. (See page 18 “Storage Period of Backup Data”.)

Cause: An attempt was made to record from a digital input source, but the source is not connected by the optical cable (“D. In Unlock” appears).

Remedy: Connect the digital input source using the optical cable or set the INPUT button to ANALOG “MO” or “ST”.

- **The disc name or track name cannot be entered.**

Cause: The disc is record-protected (“Protected” appears).

Remedy: Close the record-protect slot (See page 18).

Cause: A premastered (read-only) disc is inserted (“Cannot Rec” appears).

Remedy: Replace it with a recordable disc.

If the unit does not operate properly even after you attempt the prescribed remedies, unplug and then plug in the power cord again.

Condensation

This is the same phenomenon that causes windows to mist with water drops in a heated room during the winter.

The MD recorder also sometimes gets dew (water drops) on the optical lens inside the player under the following conditions.

- Immediately after you turn a heater on.
- If the MD recorder is placed in a room full of steam or dampness.
- If you suddenly bring the MD recorder in from the cold outside into a warm room.

If the MD recorder is exposed to dew condensation

You can leave it as it is. Sometimes the recorder cannot read the signal sent from the disc by laser and the recorder doesn't work.

Depending on the surrounding conditions, you can remove the disc and leave the power on for one hour at the longest. The dew will evaporate and the recorder will work properly. If it doesn't work after several hours, please consult the nearest ONKYO authorized service center.

Rules for digital recording

Guide to the Serial Copy Management System

Since your MD unit uses the Serial Copy Management System (SCMS), MDs recorded through the digital input terminal cannot be used to make subsequent copies to other MDs through the digital output terminal. The following diagram shows a system for making copies through the digital or analog terminals.

Rule 1

You can record digital source (CD, prerecorded MD, and DAT equipment with a sampling frequency of 44.1 kHz) to a recordable MD through the digital input terminal.

However, you cannot make subsequent copies from a recordable MD to other recordable MDs through the digital output terminal. Subsequent copies can be made only through an analog output terminal.

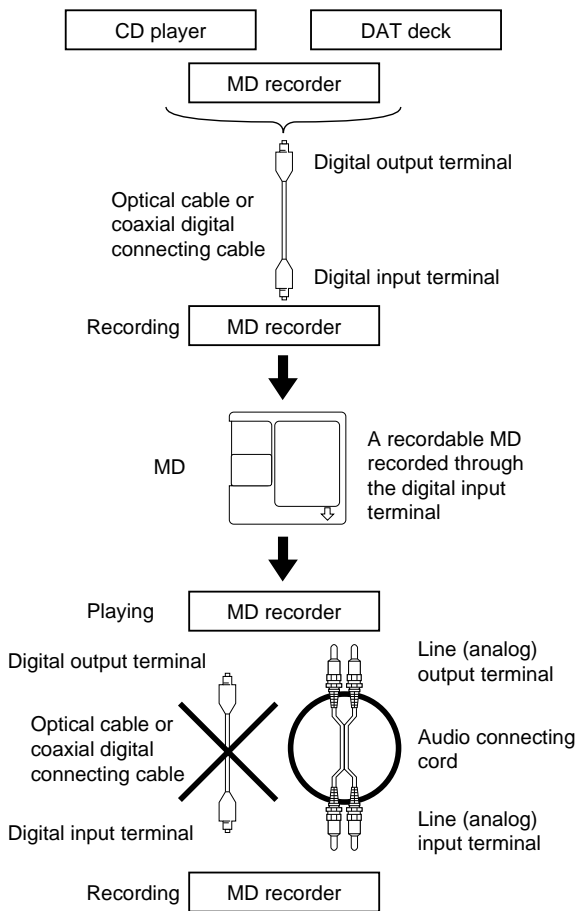

Rule 2

You can record the digital input signal of a digital satellite broadcast onto a recordable MD via the digital input terminals on an MD recorder that is capable of handling a sampling frequency of 32 kHz or 48 kHz. You can then record the contents of this recorded MD (first-generation) onto another recordable MD via the digital input terminals on the MD recorder to create a second-generation digital copy.

Note, however, that with some BS tuners, second-generation digital copying may not be possible.

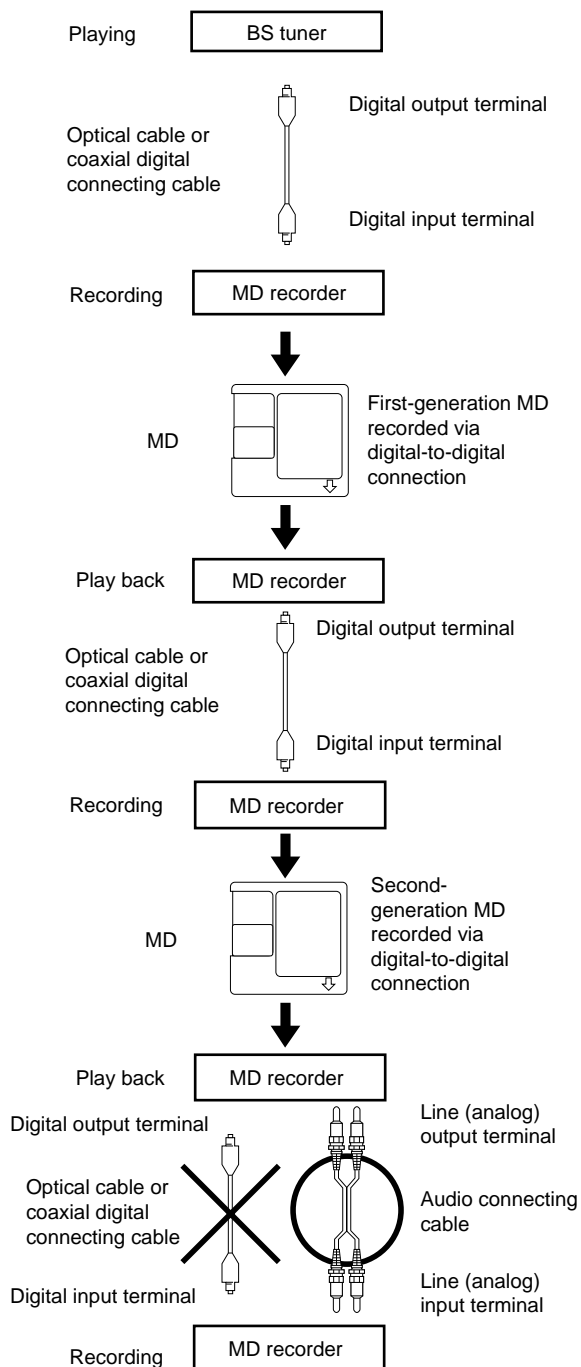

Rules for digital recording

Rule 3

A recordable MD with material recorded from analog sources (analog records or FM programs, etc.) through the line input terminal can be copied to another recordable MD through the digital output terminal.

However, you cannot make subsequent copies from the recordable MD to other recordable MDs through the digital output terminal. Subsequent copies can be made only through an analog output terminal.

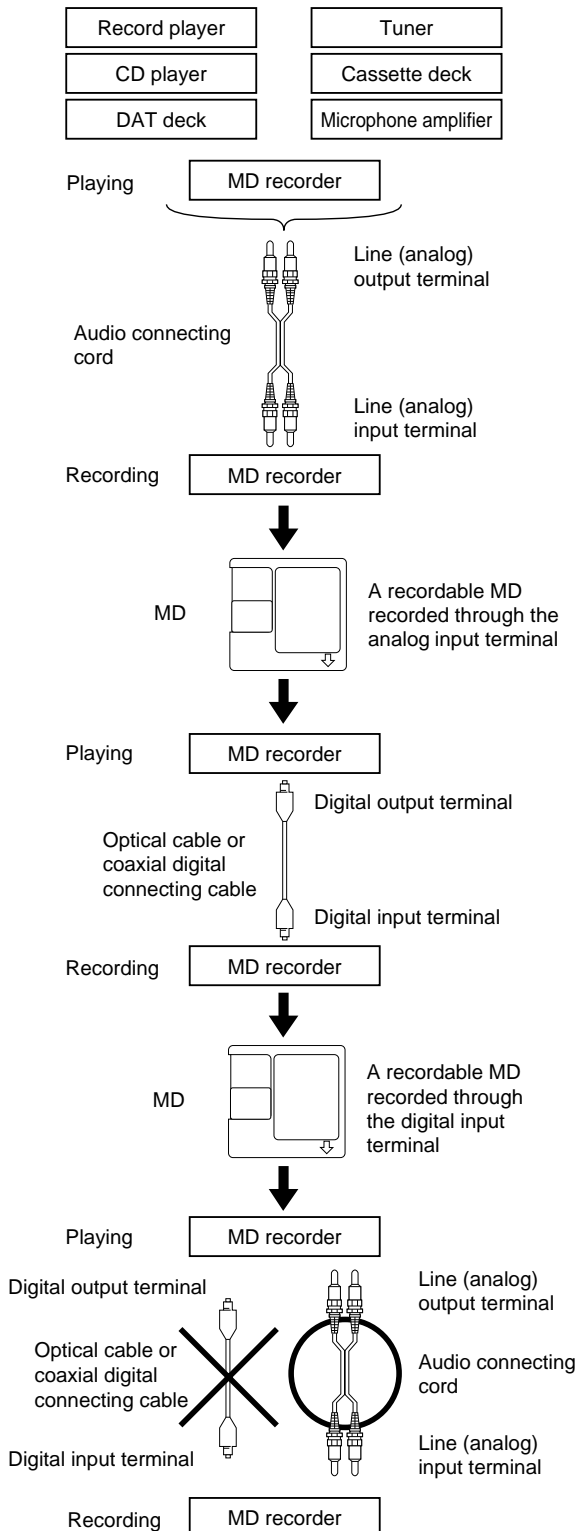

When MD recorders are connected using analog terminals, the number of dubbings is not limited.

System limitations

The recording system in your MiniDisc recorder is radically different from those used in cassette and DAT decks and is characterized by the limitations described below. Note, however, that these limitations are due to the inherent nature of the MD recording system itself and not to mechanical causes.

- “Disc Full” lights up even before the disc has reached the maximum recording time (60 or 74 minutes)**
 When 255 tracks have been recorded on the disc, “Disc Full” lights up regardless of the total recorded time. More than 255 tracks cannot be recorded on the disc. To record new tracks, erase unnecessary tracks or use another MD.
- “Disc Full” lights up before the maximum number of tracks is reached**
 Fluctuations in emphasis within tracks are sometimes interpreted as track intervals, incrementing the track count and causing the “Disc Full” indication to light up.
- The remaining recording time does not increase even after you erase numerous short tracks**
 Tracks under 12 seconds in length are not counted and so erasing them may not lead to an increase in the recording time.
- Some tracks cannot be combined with others**
 Track combination may become impossible when tracks are edited.
- The total recorded time and the remaining time on the disc may not total the maximum recording time (60 or 74 minutes)**
 Recording is done in minimum units of two seconds each, no matter how short the material. The contents recorded may thus be shorter than the maximum recording capacity. Disc space may also be further reduced by scratches.
- Tracks created through editing may exhibit sound dropout during searching operations**
- Track numbers are not recorded correctly**
 Incorrect assignment or recording of track numbers may result (1) when CD tracks are divided into several smaller tracks during digital recording, or (2) when certain CDs are recorded with both the LEVEL-SYNC indicator on and the automatic track marking function on.
- TOC indicator appears for a long time**
 If the inserted recordable disc is brand new, the TOC indicator appears on the display longer than used discs.

Control positions and names

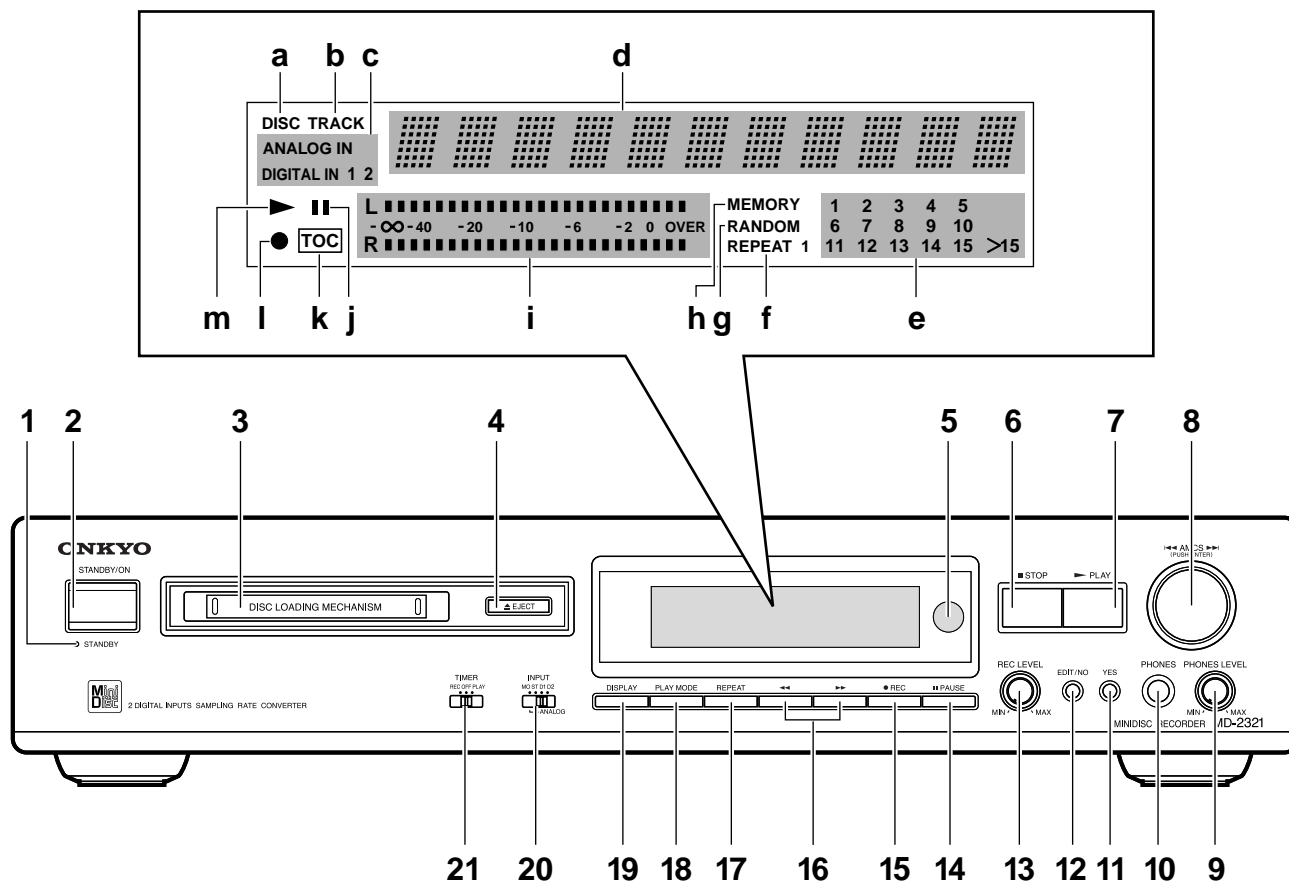

Front panel

If there is a protective film on the surface of the display, which is making it difficult to read the display, remove it.

For more information about a button or control, turn to the page number listed in square brackets [].

1. Stand-by indicator (STANDBY) [5]
2. Stand-by/On button (STANDBY/ON) [7, 12, 14]
3. Disc slot [7, 12, 14, 18]
4. Eject button (▲ EJECT) [8]
5. Remote sensor [5]
6. Stop button (■STOP) [7]
7. Play button (▶PLAY) [7, 10, 13, 15, 17, 19]
8. AMCS knob (◀◀ AMCS ▶▶) [9, 12, 14, 19-25]
9. Phones level control knob (PHONES LEVEL) [8]
10. Headphone jack (PHONES) [8]
11. Yes button (YES) [15, 16, 20-25]
12. Edit/No button (EDIT/NO) [15, 16, 20-25]
13. Rec level control knob (REC LEVEL) [15]
14. Pause button (⏸ PAUSE) [7, 13, 15, 21]
15. REC button (●REC) [13, 15, 16]
16. FF/FR buttons (◀◀, ▶▶) [10, 25]
17. Repeat button (REPEAT) [11]
18. Play mode button (PLAY MODE) [10, 19]
19. Display button (DISPLAY) [8, 24]
20. Input button (INPUT) [12, 14, 16]
21. Timer button (TIMER) [18]

Display

- a. DISC indicator
- b. TRACK indicator
- c. Input setting indicator
- d. Time/Title display
- e. Track number display
- f. REPEAT indicator
- g. RANDOM indicator
- h. Memory indicator
- i. Peak level meter
- j. Pause indicator
- k. TOC indicator
- l. REC indicator
- m. Play indicator

Control positions and names

Remote controller

You can use the following buttons to control your MD recorder.

1. **POWER** button [7]
2. **PLAY MODE** buttons [10, 19]
3. **Number** buttons [9, 19, 25]
4. **REPEAT** button [11]
5. **A-B REPEAT** button [11]
6. **A.SPACE** button [17]
7. **M.SCAN** button [10]
8. **CLEAR** button [19, 25]
9. **ENTER** button [25]
10. **NAME** button [24, 25]
11. **DISPLAY** button [8, 24]
12. **Operation** buttons
 - :Stop button [7]
 - ▶ :Play button [7]
 - || :Pause button [7, 13, 21]
 - REC :Rec button [13, 15, 16]
 - ◀◀ :Fast Reverse button [10, 25]
 - ▶▶ :Fast Forward button [10, 25]
 - ⏮ :Down button [9]
 - ⏭ :Up button [9]
13. **SCROLL** button [8]

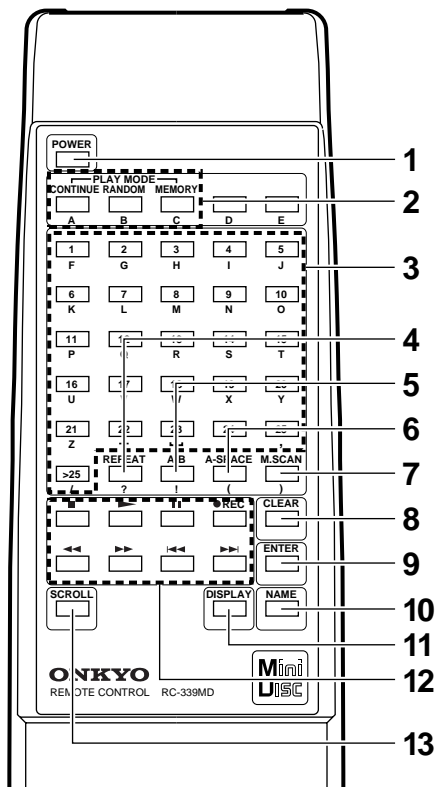

Specifications

System:	MiniDisc digital audio system
Recording system:	Magnetic field modulation overwrite system
Signal read out system:	Optical non-contact
Recording time:	Max. 74 min. (STEREO) (when using MDW-74) Max. 148 min. (MONAURAL)
Number of revolutions:	About 400-900 rpm (constant linear velocity)
Error correction system:	Advanced Cross Interleave Reed-solomon code
Sampling frequency:	44.1 kHz
Number of channels:	2 (stereo)
Frequency response:	10 Hz - 20 kHz
Signal to noise ratio:	98 dB or more when playing
Output level:	2.0 V r.m.s.
Power supply rating:	AC 230 V, 50 Hz AC 120 V, 60 Hz
Power consumption:	14W
Dimensions (W×H×D):	435 × 91 × 307 mm (17-1/8" × 3-9/16" × 12-1/16")
Weight:	4.2 kg (9.3 lbs.)

Specifications and features are subject to change without notice.

ONKYO CORPORATION

Sales & Product Planning Div. : 2-1, Nisshin-cho, Neyagawa-shi, OSAKA 572-8540, JAPAN
Tel: 0720-31-8111 Fax: 0720-33-5222

ONKYO U.S.A. CORPORATION

200 Williams Drive, Ramesy, N.J. 07446, U.S.A.
Tel: 201-825-7950 Fax: 201-825-8150 E-mail: onkyo@onkyousa.com

ONKYO EUROPE ELECTRONICS GmbH

Industriestrasse 20, 82110 Germering, GERMANY
Tel: 089 84 93 20 Fax: 089 84 93 226 E-mail: info@onkyo.de

ONKYO EUROPE FRANCE BRANCH

Domaine Technologique de Saclay 4, Rue René Razel, SACLAY-91892
ORSAY CEDEX, FRANCE Tel: (1) 69 33 14 00 Fax: (1) 69 41 35 84

ONKYO CHINA LIMITED

Units 2102-7, Metroplaza Tower I, 223 Hing Fong Road, Kwai Chung,
N.T., HONG KONG Tel: 852 2429 3118 Fax: 852 2428 9039

